

2024

Update 2024

**beds, sofas
and armchairs
camas, sofás
y sillones**

Price list

AD1

Twils®

Bed bases

Somieres de apoyo - Sommiers à poser

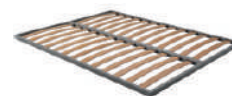

ORTOPEDIC with metal frame

ORTOPEDIC con estructura metálica - ORTOPEDIC avec structure en metal

Bed bases Somieres Sommier	Code Código Code	190	200	210	Two-piece bed base Somier en dos piezas Sommier en deux pièces	m ³	kg
		3	5	7			
200	RETE0520.	575	580	695	+235	0,2	28
193	RETE0519K.	-	605	-	+235	0,2	28
180	RETE0518.	375	375	420	+235	0,2	28
170	RETE0517.	375	375	420	+235	0,17	25
160	RETE0516.	315	315	360	+235	0,17	25
153	RETE0515Q.	-	315	-	+235	0,2	28
140	RETE0514.	315	315	360	+235	0,14	22
120	RETE0512.	280	280	305	-	0,12	18
100	RETE0510.	280	280	305	-	0,1	16
90	RETE0509.	235	235	280	-	0,09	14
80	RETE0508.	210	210	260	-	0,08	13

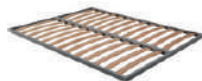

ORTOPEDIC PLUS with metal frame

ORTOPEDIC PLUS con estructura metálica - ORTOPEDIC PLUS avec structure en metal

Bed bases Somieres Sommier	Code Código Code	190	200	210	Two-piece bed base Somier en dos piezas Sommier en deux pièces	m ³	kg
		3	5	7			
200	RETE0520.	645	650	760	+305	0,2	28
193	RETE0519K.	-	675	-	+305	0,2	28
180	RETE0518.	445	445	490	+305	0,2	28
170	RETE0517.	445	445	490	+305	0,17	25
160	RETE0516.	385	385	430	+305	0,17	25
153	RETE0515Q.	-	385	-	+305	0,2	28
140	RETE0514.	385	385	430	+305	0,14	22
120	RETE0512.	-	-	-	-	-	-
100	RETE0510.	325	315	340	-	0,1	16
90	RETE0509.	270	270	315	-	0,09	14
80	RETE0508.	245	245	290	-	0,08	13

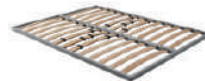

ONE with metal frame

ONE con estructura metálica - ONE avec structure en metal

Bed bases Somieres Sommier	Code Código Code	190	200	210	Two-piece bed base Somier en dos piezas Sommier en deux pièces	m ³	kg
		3	5	7			
180	RETE0618.	-	490	-	-	0,26	30
160	RETE0616.	445	445	-	-	0,24	27

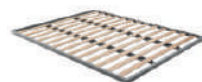

COMFORT with metal frame

COMFORT con estructura metálica - COMFORT avec structure en metal

Bed bases Somieres Sommier	Code Código Code	190	200	210	Two-piece bed base Somier en dos piezas Sommier en deux pièces	m ³	kg
		3	5	7			
180	RETE1118.	-	665	-	+175	0,18	38
160	RETE1116.	605	605	-	+175	0,16	33
120	RETE1112.	-	455	-	+175	0,12	23
90	RETE1109.	-	375	-	+175	0,09	18



WOOD with wooden frame

WOOD con estructura de madera - WOOD avec structure en boismetal

Bed bases Somieres Sommier	Code Código Code	190	200	210	Two-piece bed base Somier en dos piezas Sommier en deux pièces	m ³	kg
		3	5	7			
180	RETE0518.	-	385	-	-	0,26	32
170	RETE0517.	-	385	-	-	0,25	30
160	RETE0516.	-	350	-	-	0,22	30
140	RETE0514.	-	325	-	-	0,16	20
120	RETE0512.	-	280	-	-	0,15	18
100	RETE0510.	-	280	-	-	0,12	17
90	RETE0509.	-	195	-	-	0,11	16
80	RETE0508.	-	175	-	-	0,10	15



MOON with metal frame

MOON con estructura metálica - MOON avec structure en metal

Bed bases Somieres Sommier	Code Código Code	190	200	210	Two-piece bed base Somier en dos piezas Sommier en deux pièces	m ³	kg
		3	5	7			
193	RETE0719K.	-	830	-	+190	0,32	40
180	RETE0718.	630	630	-	+190	0,29	36
160	RETE0716.	570	570	-	+190	0,26	32
153	RETE0715Q.	-	570	-	+190	0,25	30

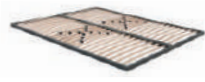

WOOD PLUS with wooden frame

WOOD PLUS con estructura de madera - WOOD PLUS avec structure en boismetal

Bed bases Somieres Sommier	Code Código Code	190	200	210	Two-piece bed base Somier en dos piezas Sommier en deux pièces	m ³	kg
		3	5	7			
180	RETE0518.	-	455	-	-	0,26	32
170	RETE0517.	-	455	-	-	0,25	30
160	RETE0516.	-	420	-	-	0,22	30
140	RETE0514.	-	395	-	-	0,16	20
120	RETE0512.	-	325	-	-	0,15	18
100	RETE0510.	-	325	-	-	0,12	17
90	RETE0509.	-	240	-	-	0,11	16
80	RETE0508.	-	225	-	-	0,10	15



ERGONOMIC with wooden frame

ERGONOMIC con estructura de madera - ERGONOMIC avec structure en boismetal

Bed bases Somieres Sommier	Code Código Code	190	200	210	Two-piece bed base Somier en dos piezas Sommier en deux pièces	m ³	kg
		3	5	7			
180	RETE2118.	-	780	-	-	0,26	28
170	RETE2117.	-	780	-	-	0,25	25
160	RETE2116.	-	745	-	-	0,23	25
140	RETE2114.	-	630	-	-	0,17	20
120	RETE2112.	-	490	-	-	0,15	17
100	RETE2110.	-	490	-	-	0,12	16
90	RETE2109.	-	390	-	-	0,11	14
80	RETE2108.	-	375	-	-	0,10	13

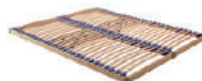

ERGO PLUS with wooden frame

ERGO PLUS con estructura de madera - ERGO PLUS avec structure en boismetal

Bed bases Somieres Sommier	Code Código Code	190	200	210	Two-piece bed base Somier en dos piezas Sommier en deux pièces	m ³	kg
		3	5	7			
200	RETE4120.	3.160	3.160	-	-	0,50	45
180	RETE4118.	2.530	2.530	-	-	0,29	37
160	RETE4116.	2.475	2.530	-	-	0,24	29
100	RETE4110.	1.580	1.580	-	-	0,21	23
90	RETE4109.	1.265	1.265	-	-	0,12	19
80	RETE4108.	1.240	1.265	-	-	0,10	15



Bed base with electrically adjustable head/foot sections and wooden free with anatomical supports and weight regulators.
Somier con mecanismo de elevación del cabecero/piecerro motorizado con soportes anatómicos y reguladores de peso.
Sommier électrique avec tête et pieds relevables, avec support anatomiques et régulateurs de poids.



Wireless remote controller
Control remoto inalámbrico
Télécommande sans fil

Pcs.
+ 215 Pcs.
Pièce



Double cable, to control two motors with a push-button panel
Cable doble, para controlar dos motores con un panel de botones.
Double câble pour contrôler deux moteurs avec un clavier

+ 165

Beds

Camas - Lits

- 4 Canalgrande
- 8 Elle
- 10 Infinito basso
- 14 Infinito alto
- 18 Infinito Accessories
Accesorios - Accessoires

Sofas

Sofás - Canapés

- 20 Biggie FREESTYLE
- 24 Biggie Mono
- 28 Briò
- 36 Chain
- 40 Kamari
- 46 Nathan
- 58 Raphael
- 70 Tudor
- 76 Wilson

Armchairs

Sillón - Fauteuils

- 82 Brioche

Coffee tables

Mesitas - Petites tables

- 84 Otto
- 84 Orion Tondo

Canalgrande

Upholstered bed with bed frame H. 15 / 25

Cama tapizada con aro de cama H. 15 / 25

Lit rembourré avec cadre de lit H. 15 / 25

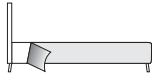

Removable cover (no leather)

Funda desenfundable (no en piel)

Housse amovible (pas de cuir)



Prices difference from the standard feet

Diferencia de precios respecto a las patas estándar











Différence de prix par rapport au pied standard

In the leather version, the headboard and bed frame have one or more seams based on the size of the tanned leather

En la versión de piel, el cabecero y la estructura de la cama tienen una o más costuras según el tamaño del curtido

Dans la version cuir, la tête de lit et le cadre de lit ont une ou plusieurs coutures, selon la taille du tannage du cuir

▲
Pair of wheels on request
Par de ruedas a solicitud
Paire de roues sur demande

		W	M	T	F	K	V	L	X	Z	H	B
												
		Bianco	Madreperla	Tortora	Fumo	Noce canaletto	Termocotto	Alluminio lucido	Brown Bronze	Grafite	Black nichel	Nero opaco
H. 15	PIE6G											
H. 15	H. 18					0	0					
H. 25	PIE4G											
H. 25	H. 12					0	0					

Shelf included in the price

Estante incluido en el precio

Etagère incluse dans le prix

Shelf color

Color del estante

Couleur des étagères

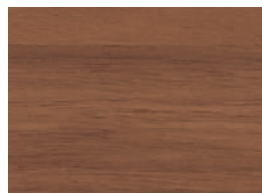

Noce canaletto

Bed frame H. 15 with structural bed base (Ortopedic bed base)

Aro de cama H. 15 con somier estructural (somier Ortopedic)
Cadre de lit H. 15 avec sommier structurel (sommier Ortopedic)

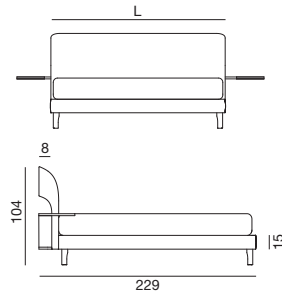

Bed base/ mattress size Medida de somier/colchón Mesure sommier/matelas	Bed code Código cama Code lit	H.L.P.	Fabrics - Telas - Tissu				Leather - Piel - Cuir			C.O.M. fabric L./H. Tela cliente Tissu client	m ³	kg	
			Cat. B	Cat. C/D	Cat. Must	Cat. K	Cat. E	Cat. Plus	Cat. Luxury				
193x203	12419K63N	104x 287 x232	4.400	4.560	4.715	4.870	5.805	6.590	7.210	4.400	6,75/1,40	0,60	55
180x200	12418563N	104x 272 x229	3.830	3.975	4.110	4.250	5.090	5.795	6.355	3.830	6,05/1,40	0,59	52
160x200	12416563N	104x 254 x229	3.640	3.765	3.890	4.015	4.760	5.390	5.885	3.640	5,40/1,40	0,54	46
153x203	12415Q63N	104x 247 x232	3.785	3.915	4.035	4.165	4.910	5.535	6.035	3.785	5,40/1,40	0,54	44

Bed for bed base or mattress with length 190 cm, no extra charge. With length 210 cm, extra charge (excluded dimensions 153x203 and 193x203)
Cama para somier o colchón largo 190 cm, sin recargo. Largo 210 cm, recargo (dimensiones excluidas 153x203 y 193x203)
Lit pour sommier ou matelas profondeur 190 cm sans supplément. Avec une profondeur de 210 cm, supplément (hors mesures 153x203 et 193x203)

+240



Cod. **PIE6G**
H. 17

For additional cover see page. 19
Para funda adicional, consultar página. 19
Pour housse supplémentaire, voir p. 19

For the choice of mattress see page 235 (price list 2023)
Para la elección del colchón consultar página 235 (lista de precios 2023)
Pour le choix du matelas voir p. 235 (tarif 2023)

Bed frame H. 15 without bed base

Aro de cama H. 15 sin somier
Cadre de lit H. 15 sans sommier

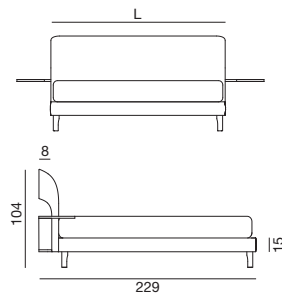

Bed base/ mattress size Medida de somier/colchón Mesure sommier/matelas	Bed code Código cama Code lit	H.L.P.	Fabrics - Telas - Tissu				Leather - Piel - Cuir			C.O.M. fabric L./H. Tela cliente Tissu client	m ³	kg	
			Cat. B	Cat. C/D	Cat. Must	Cat. K	Cat. E	Cat. Plus	Cat. Luxury				
193x203	12419K63I	104x 287 x232	4.135	4.290	4.450	4.755	5.540	6.315	6.940	4.135	6,75/1,40	0,50	47
180x200	12418563I	104x 272 x229	3.885	4.030	4.170	4.450	5.150	5.850	6.415	3.885	6,05/1,40	0,49	44
160x200	12416563I	104x 254 x229	3.775	3.895	4.025	4.275	4.900	5.520	6.020	3.775	5,40/1,40	0,44	39
153x203	12415Q63I	104x 247 x232	3.860	3.990	4.110	4.360	4.990	5.610	6.105	3.860	5,40/1,40	0,44	37

Bed for bed base or mattress with length 190 cm, no extra charge. With length 210 cm, extra charge (excluded dimensions 153x203 and 193x203)
Cama para somier o colchón largo 190 cm, sin recargo. Largo 210 cm, recargo (dimensiones excluidas 153x203 y 193x203)
Lit pour sommier ou matelas profondeur 190 cm sans supplément. Avec une profondeur de 210 cm, supplément (hors mesures 153x203 et 193x203)

+240



Cod. **PIE6G**
H. 17

For additional cover see page. 19
Para funda adicional, consultar página. 19
Pour housse supplémentaire, voir p. 19

For bed bases see page 252 (price list 2023)
Para somier consultar página 252 (lista de precios 2023)
Pour les sommiers voir p. 252 (tarif 2023)

For the choice of mattress see page 235 (price list 2023)
Para la elección del colchón consultar página 235 (lista de precios 2023)
Pour le choix du matelas voir p. 235 (tarif 2023)

Bed frame H. 15 A - (without bed base)

Aro de cama H. 15 A - (sin somier)

Cadre de lit H. 15 A - (sans sommier)

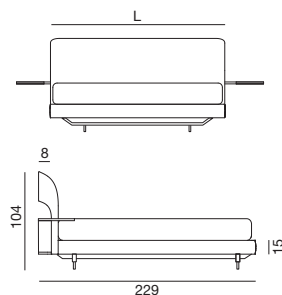

Bed base/ mattress size Medida de somier/colchón Mesure sommier/matelas	Bed code Código cama Code lit	H.L.P.	Fabrics - Telas - Tissu				Leather - Piel - Cuir			C.O.M. fabric L./H. Tela cliente Tissu client	m ³	kg	
			Cat. B	Cat. C/D	Cat. Must	Cat. K	Cat. E	Cat. Plus	Cat. Luxury				
193x203	12419K63A	104x 287 x232	4.245	4.395	4.555	4.865	5.650	6.425	7.050	4.245	6,75/1,40	0,50	47
180x200	12418563A	104x 272 x229	3.980	4.120	4.255	4.535	5.235	5.940	6.500	3.980	6,05/1,40	0,49	44
160x200	12416563A	104x 254 x229	3.835	3.955	4.085	4.330	4.960	5.580	6.080	3.835	5,40/1,40	0,44	39
153x203	12415Q63A	104x 247 x232	3.910	4.035	4.160	4.415	5.035	5.660	6.160	3.910	5,40/1,40	0,44	37

Bed for bed base or mattress with length 190 cm, no extra charge.
Cama para somier o colchón largo 190 cm, sin recargo.
Lit pour sommier ou matelas profondeur 190 cm sans supplément.

 For additional cover see page. 19
Para funda adicional, consultar página. 19
Pour housse supplémentaire, voir p. 19

 For bed bases see page 252 (price list 2023)
Para somier consultar página 252 (lista de precios 2023)
Pour les sommiers voir p. 252 (tarif 2023)

 For the choice of mattress see page 235 (price list 2023)
Para la elección del colchón consultar página 235 (lista de precios 2023)
Pour le choix du matelas voir p. 235 (tarif 2023)

Bed frame H. 15 A - Box with storage (Ortopedic Plus bed base)

Aro de cama H. 15 A - Box con arcon
(Somier Ortopedic Plus)

Cadre de lit H. 15 A - Box avec coffre
(sommier Ortopedic Plus)

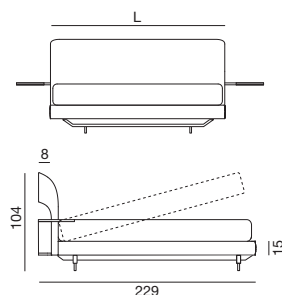

Bed base/ mattress size Medida de somier/colchón Mesure sommier/matelas	Bed code Código cama Code lit	H.L.P.	Fabrics - Telas - Tissu				Leather - Piel - Cuir			C.O.M. fabric L./H. Tela cliente Tissu client	m ³	kg	
			Cat. B	Cat. C/D	Cat. Must	Cat. K	Cat. E	Cat. Plus	Cat. Luxury				
193x203	12419K63A KBTAB019K	104x 287 x232	5.720	5.870	6.030	6.340	7.125	7.900	8.525	5.720	6,75/1,40	0,87	157
180x200	12418563A KBTAB0185	104x 272 x229	5.350	5.490	5.625	5.905	6.605	7.310	7.870	5.350	6,05/1,40	0,73	144
160x200	12416563A KBTAB0165	104x 254 x229	5.140	5.260	5.390	5.635	6.265	6.885	7.385	5.140	5,40/1,40	0,71	140
153x203	12415Q63A KBTAB015Q	104x 247 x232	5.300	5.425	5.550	5.805	6.425	7.050	7.550	5.300	5,40/1,40	0,65	140

Bed for bed base or mattress with length 190 cm, no extra charge.
Cama para somier o colchón largo 190 cm, sin recargo.
Lit pour sommier ou matelas profondeur 190 cm sans supplément.

Technical Sheet storage box and accessories see page 23-26 (price list 2023)
Hoja tecnica arcon consultar página 23-26 (lista de precios 2023)
Coffre de rangement: fiche technique et accessoires voir p. 23-26 (tarif 2023)

 For additional cover see page. 19
Para funda adicional, consultar página. 19
Pour housse supplémentaire, voir p. 19

 For storage box with no standard bed base see page 25 (price list 2023)
Para arcon sin somier estándar consultar página 25 (lista de precios 2023)
Pour Coffre de rangement avec sommiers non standard voir p. 25 (tarif 2023)

 For the choice of mattress see page 235 (price list 2023)
Para la elección del colchón consultar página 235 (lista de precios 2023)
Pour le choix du matelas voir p. 235 (tarif 2023)

Bed frame H. 25 without bed base

Aro de cama H. 25 sin somier
Cadre de lit H. 25 sans sommier

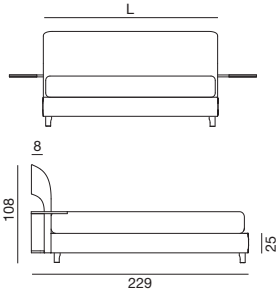

Bed base/ mattress size Medida de somier/colchón Mesure sommier/matelas	Bed code Código cama Code lit	H.L.P.	Fabrics - Telas - Tissu				Leather - Piel - Cuir			C.O.M. fabric L./H. Tela cliente Tissu client	m ³	kg	
			Cat. B	Cat. C/D	Cat. Must	Cat. K	Cat. E	Cat. Plus	Cat. Luxury				
193x203	12419K67N	108x287x232	3.625	3.805	3.980	4.160	5.215	6.095	6.805	3.625	6,75/1,40	0,50	47
180x200	12418567N	108x272x229	3.460	3.620	3.780	3.940	4.900	5.695	6.335	3.460	6,05/1,40	0,49	44
160x200	12416567N	108x254x229	3.350	3.490	3.635	3.780	4.640	5.355	5.920	3.350	5,40/1,40	0,44	39
153x203	12415Q67N	108x247x232	3.360	3.505	3.640	3.785	4.645	5.360	5.925	3.360	5,40/1,40	0,44	37

Bed for bed base or mattress with length 190 cm, no extra charge. With length 210 cm, extra charge (excluded dimensions 153x203 and 193x203)
Cama para somier o colchón largo 190 cm, sin recargo. Largo 210 cm, recargo (dimensiones excluidas 153x203 y 193x203)
Lit pour sommier ou matelas profondeur 190 cm sans supplément. Avec une profondeur de 210 cm, supplément (hors mesures 153x203 et 193x203)

+240

Float Suite 25 (disappearing feet system)
Float Suite 25 (sistema de patas que desaparece)
Float Suite 25 (système de pieds disparaissants)

+210



Cod. **PIE4G**
H. 12

For additional cover see page. 19
Para funda adicional, consultar página. 19
Pour housse supplémentaire, voir p. 19

For bed bases see page 252 (price list 2023)
Para somier consultar página 252 (lista de precios 2023)
Pour les sommiers voir p. 252 (tarif 2023)

For the choice of mattress see page 235 (price list 2023)
Para la elección del colchón consultar página 235 (lista de precios 2023)
Pour le choix du matelas voir p. 235 (tarif 2023)

Bed frame H. 25 with storage (Ortopedic Plus bed base)

Aro de cama H. 25 con arcon
(Somier Ortopedic Plus)
Cadre de lit H. 25 avec coffre
(sommier Ortopedic Plus)

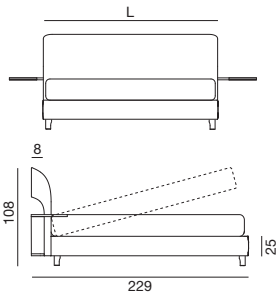

Bed base/ mattress size Medida de somier/colchón Mesure sommier/matelas	Bed code Código cama Code lit	H.L.P.	Fabrics - Telas - Tissu				Leather - Piel - Cuir			C.O.M. fabric L./H. Tela cliente Tissu client	m ³	kg	
			Cat. B	Cat. C/D	Cat. Must	Cat. K	Cat. E	Cat. Plus	Cat. Luxury				
193x203	12419K67N KBT80019K	108x287x232	4.915	5.095	5.270	5.450	6.505	7.385	8.095	4.915	6,75/1,40	0,87	157
180x200	12418567N KBT800185	108x272x229	4.450	4.610	4.770	4.930	5.890	6.685	7.325	4.450	6,05/1,40	0,73	144
160x200	12416567N KBT800165	108x254x229	4.220	4.360	4.505	4.650	5.510	6.225	6.790	4.220	5,40/1,40	0,71	140
153x203	12415Q67N KBT80015Q	108x247x232	4.230	4.375	4.510	4.655	5.515	6.230	6.795	4.230	5,40/1,40	0,65	140

Bed for bed base or mattress with length 190 cm, no extra charge. With length 210 cm, extra charge (excluded dimensions 153x203 and 193x203)
Cama para somier o colchón largo 190 cm, sin recargo. Largo 210 cm, recargo (dimensiones excluidas 153x203 y 193x203)
Lit pour sommier ou matelas profondeur 190 cm sans supplément. Avec une profondeur de 210 cm, supplément (hors mesures 153x203 et 193x203)

+240

Float Suite 25 (disappearing feet system)
Float Suite 25 (sistema de patas que desaparece)
Float Suite 25 (système de pieds disparaissants)

+210



Cod. **PIE4G**
H. 12

Box contenitore: scheda tecnica e accessori vedi pag. 23-26 (price list 2023)
Technical Sheet storage box and accessories see page 23-26 (lista de precios 2023)
Hoja tecnica arcon consultar página 23-26 (tarif 2023)

For additional cover see page. 19
Para funda adicional, consultar página. 19
Pour housse supplémentaire, voir p. 19

For storage box with no standard bed base see page 25 (price list 2023)
Para arcon sin somier estándar consultar página 25 (lista de precios 2023)
Pour Coffre de rangement avec sommiers non standard voir p. 25 (tarif 2023)

For the choice of mattress see page 235 (price list 2023)
Para la elección del colchón consultar página 235 (lista de precios 2023)
Pour le choix du matelas voir p. 235 (tarif 2023)

Elle

Upholstered bed with bed frame H. 9

Cama tapizada con aro de cama H. 9

Lit rembourré avec cadre de lit H. 9

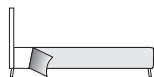

Removable cover (no leather)

Funda desenfundable (no en piel)

Housse amovible (pas de cuir)



Prices difference from the standard feet

Diferencia de precios respecto a las patas estándar











Différence de prix par rapport au pied standard

In the leather version, the headboard and bed frame have one or more seams based on the size of the tanned leather

En la versión de piel, el cabecero y la estructura de la cama tienen una o más costuras según el tamaño del curtido

Dans la version cuir, la tête de lit et le cadre de lit ont une ou plusieurs coutures, selon la taille du tannage du cuir

▲ Pair of wheels on request
Par de ruedas a solicitud
Paire de roues sur demande

	W	M	T	F	K	V	L	X	Z	H	B
											
H. 9	PIE8EH										
H. 24										0	

Moon

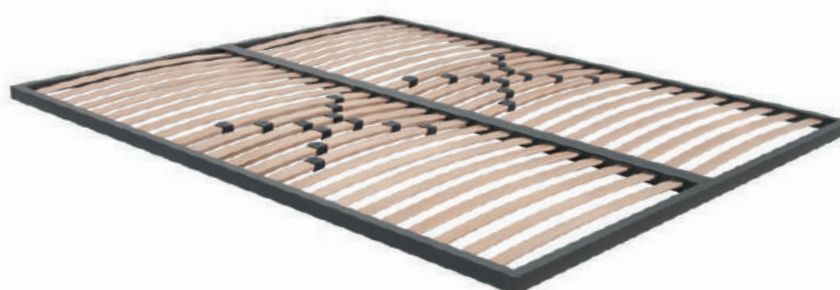

Central longitudinal rail

Doble perfil central
Double profil central

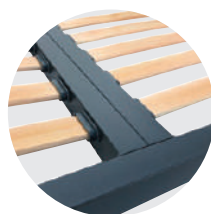

Weight regulators

Reguladores del peso
Régulateurs de poids



Rounded corners

Esquinas cuadradas
Coins carrés



Structural bed base with metal structure, 48 slats.

- 50x25 mm square section painted metal frame
- Double beds with 30x40 mm central longitudinal rail
- 48 steam-bent beech slats 38x8 mm (slats size 200)
- 12 double slats with weight regulators in the central part

Somier estructural con estructura metálica, 48 lamas.

- Perfil escuadrado de 50x25 mm de metal pintado,
- Versiones matrimoniales con dos perfiles centrales de 30x40 mm.
- 48 laminas de haya conformada mediante vapor de 68x8 mm (tamaño 200)
- 12 laminas dobles con reguladores de peso en la parte central.

Sommier structurel avec structure métallique 48 lattes.

- Cadre à section carrée 50x25 mm en métal peint
- Versions 2 places avec double profilé 30x40mm
- 48 lattes en hêtre profilé à la veur de 38x8 mm (sommier taille 200)
- 12 doubles lattes avec régulateurs de poids dans la partie centrale

Extra charge - Recargo - Suppléments

For two-piece bed base with metallic structure

Para somier en dos piezas con estructura de metal - Pour sommiers en deux pièces avec structure en bois

+ 190

Available sizes - Medidas disponibles - Tailles disponibles

L. 153 - 160 - 180 - 193 / P. 190 - 200

Bed frame H. 9 with structural bed base (Ortopedic bed base)

Aro de cama H. 9 con somier estructural (somier Ortopedic)
Cadre de lit H. 9 avec sommier structurel (sommier Ortopedic)

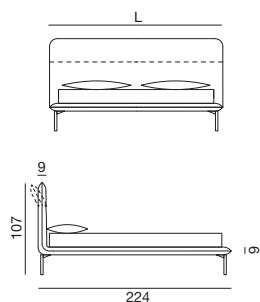

Bed base/ mattress size Medida de somier/colchón Mesure sommier/matelas	Bed code Código cama Code lit	H.L.P.	Fabrics - Telas - Tissu				Leather - Piel - Cuir			C.O.M. fabric L./H. Tela cliente Tissu client	m³	kg	
			Cat. B	Cat. C/D	Cat. Must	Cat. K	Cat. E	Cat. Plus	Cat. Luxury				
193x203	14719KL1N	107x 216 x227 (237)	2.895	3.020	3.135	3.255	3.970	4.565	5.045	2.895	5,30/1,40	0,50	47
180x200	147185L1N	107x 201 x224 (234)	2.445	2.550	2.660	2.765	3.405	3.940	4.370	2.445	4,75/1,40	0,49	44
160x200	147165L1N	107x 183 x224 (234)	2.275	2.370	2.465	2.560	3.135	3.610	3.995	2.275	4,25/1,40	0,44	39
153x203	14715QL1N	107x 176 x227 (237)	2.370	2.465	2.560	2.655	3.225	3.705	4.085	2.370	4,25/1,40	0,44	37

Bed for bed base or mattress with length 190 cm, no extra charge. With length 210 cm, extra charge (excluded dimensions 153x203 and 193x203)
Cama para somier o colchón largo 190 cm, sin recargo. Largo 210 cm, recargo (dimensiones excluidas 153x203 y 193x203)
Lit pour sommier ou matelas profondeur 190 cm sans supplément. Avec une profondeur de 210 cm, supplément (hors mesures 153x203 et 193x203)

+240



Cod. **PIE8EH Metallo black Nichel**
H. 24

For additional cover see page. 19
Para funda adicional, consultar página. 19
Pour housse supplémentaire, voir p. 19

For the choice of mattress see page 235 (price list 2023)
Para la elección del colchón consultar página 235 (lista de precios 2023)
Pour le choix du matelas voir p. 235 (tarif 2023)

Bed frame H. 9 with structural bed base Moon

Aro de cama H. 9 con somier estructural Moon
Cadre de lit H. 5 avec sommier structurel Moon

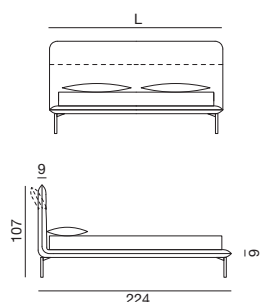

Bed base/ mattress size Medida de somier/colchón Mesure sommier/matelas	Bed code Código cama Code lit	H.L.P.	Fabrics - Telas - Tissu				Leather - Piel - Cuir			C.O.M. fabric L./H. Tela cliente Tissu client	m³	kg	
			Cat. B	Cat. C/D	Cat. Must	Cat. K	Cat. E	Cat. Plus	Cat. Luxury				
193x203	14719KL1N	107x 216 x227 (237)	2.965	3.090	3.205	3.325	4.040	4.635	5.115	2.965	5,30/1,40	0,50	47
180x200	147185L1N	107x 201 x224 (234)	2.670	2.775	2.885	2.990	3.630	4.165	4.595	2.670	4,75/1,40	0,49	44
160x200	147165L1N	107x 183 x224 (234)	2.550	2.645	2.740	2.835	3.410	3.885	4.270	2.550	4,25/1,40	0,44	39
153x203	14715QL1N	107x 176 x227 (237)	2.710	2.805	2.900	2.995	3.565	4.045	4.425	2.710	4,25/1,40	0,44	37

Bed for bed base or mattress with length 190 cm, no extra charge.
Cama para somier o colchón largo 190 cm, sin recargo.
Lit pour sommier ou matelas profondeur 190 cm sans supplément.



Cod. **PIE8EH Metallo black Nichel**
H. 24

For additional cover see page. 19
Para funda adicional, consultar página. 19
Pour housse supplémentaire, voir p. 19

For the choice of mattress see page 235 (price list 2023)
Para la elección del colchón consultar página 235 (lista de precios 2023)
Pour le choix du matelas voir p. 235 (tarif 2023)

Infinito Basso

Upholstered bed with bed frame H. 15 / 25

Cama tapizada con aro de cama H. 15 / 25

Lit rembourré avec cadre de lit H. 15 / 25

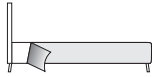

Removable cover

Funda desenfundable

Housse amovible

Prices difference from the standard feet

Diferencia de precios respecto a las patas estándar

Différence de prix par rapport au pied standard

In the leather version, the headboard and bed frame have one or more seams based on the size of the tanned leather

En la versión de piel, el cabecero y la estructura de la cama tienen una o más costuras según el tamaño del curtido

Dans la version cuir, la tête de lit et le cadre de lit ont une ou plusieurs coutures, selon la taille du tannage du cuir

		W	M	T	F	K	V	L	X	Z	H	B
		Bianco	Madreperla	Tortora	Fumo	Noce canaletto	Termocotto	Alluminio lucido	Brown Bronze	Grafite	Black nichel	Nero opaco
H. 15	PIE68											
	H. 17		0	0	0	0	0					
H. 25	FLOAT SUITE											
	H. 11											

Integrated dimmable light included in the price, with 2 radio control and magnet.

Luz integrada regulable incluida en el precio, con 2 radio control y magnético.

Lumière intégrée à intensité variable incluse dans le prix, avec 2 radiocommande et aimant.

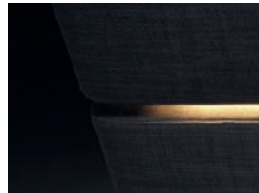

Wall panel with flush mounting box

Panel con caja de empotrar
Panneau avec boîte de dérivation

+ 115 Each
Cada - Chaque

Wifi on/off Room light control kit.

2 Bluetooth/Wifi Switches with Relay, compatible with the original wall switch. It allows you to remotely control the turning on of the room light, avoiding placing electrical cables on the headboard of the bed.

Kit de control de luz de habitación encendido/apagado WiFi.

2 Interruptores Bluetooth/Wifi con Relé, compatibles con el interruptor de pared original. Esto permite controlar de forma remota el encendido de las luces de la habitación, evitando colocar cables eléctricos en el cabecero de la cama.

Kit de contrôle de l'éclairage de la pièce marche/arrêt WiFi.

2 interrupteurs Bluetooth/WiFi avec relais, compatibles avec l'interrupteur mural d'origine. Cela permet de contrôler à distance l'allumage des lumières de la chambre sans avoir à faire passer des câbles électriques jusqu'à la tête de lit.

+ 200



Shelf finishes and prices see page 18

Aabados de estanterías y precios ver página 18

Finitions des étagères et prix voir page 18

L

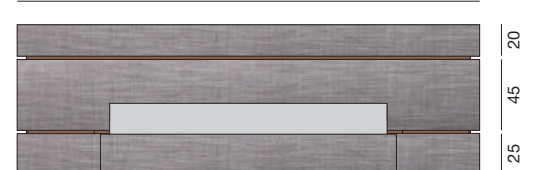

Wood insert finishing

Acabado del inserto de madera

Finition insert en bois

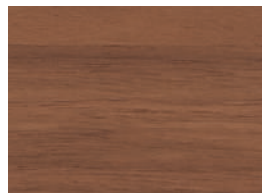

Noce canaletto

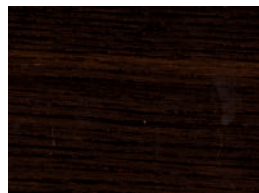

Termocotto

Painted insert finish

Acabado del inserto pintado

Finition insert laqué

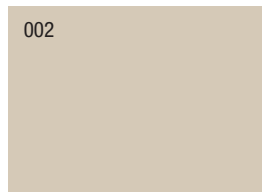

Canapa

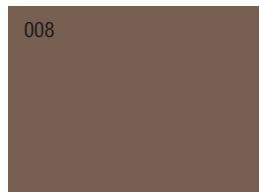

Visone



Juta

Available from January 2025

Disponible a partir de Enero de 2025

Disponible à partir de Janvier 2025

Bed frame H. 15 without bed base

Aro de cama H. 15 sin somier

Cadre de lit H. 15 sans sommier

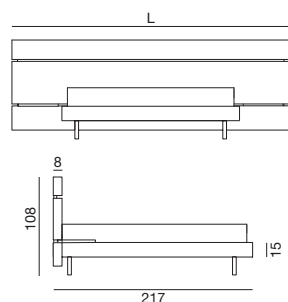

Bed base/ mattress size Medida de somier/colchón Mesure sommier/matelas	Bed code Código cama Code lit	H.L.P.	Fabrics - Telas - Tissu				Leather - Piel - Cuir			C.O.M. fabric L./H. Tela cliente Tissu client	m³	kg	
			Cat. B	Cat. C/D	Cat. Must	Cat. K	Cat. E	Cat. Plus	Cat. Luxury				
200x200	160205E3I	108x 321 x217	3.750	3.905	4.055	4.365	5.130	5.895	6.505	3.750	6,50/1,40	0,83	118
193x203	16019KE3I	108x 321 x220	3.855	4.005	4.155	4.465	5.230	5.995	6.610	3.855	6,50/1,40	0,83	118
170x200	160185E3I	108x 301 x217	3.540	3.675	3.815	4.090	4.775	5.465	6.015	3.540	6,10/1,40	0,81	113
180x200	160175E3I	108x 301 x217	3.535	3.675	3.805	4.085	4.775	5.460	6.010	3.535	6,10/1,40	0,81	113
160x200	160165E3I	108x 283 x217	3.440	3.575	3.705	3.965	4.615	5.255	5.780	3.440	5,70/1,40	0,79	109
153x203	16015QE3I	108x 283 x220	3.475	3.600	3.720	3.965	4.580	5.190	5.675	3.475	5,70/1,40	0,79	109

Bed for bed base or mattress with length 190 cm, no extra charge. With length 210 cm, extra charge (excluded dimensions 153x203 and 193x203)
Cama para somier o colchón largo 190 cm, sin recargo. Largo 210 cm, recargo (dimensiones excluidas 153x203 y 193x203)

Lit pour sommier ou matelas profondeur 190 cm sans supplément. Avec une profondeur de 210 cm, supplément (hors mesures 153x203 et 193x203)

+280

**EXTRA CHARGE for customization of headboard panels.
Upholstered with fabric belonging to different categories from the bed cover (excluded leather).**

RECARGO para personalizar los paneles del cabecero de la cama.

Tapizado con telas pertenecientes a categorías distintas a la de cubrecamas (excluido cuero).

SUPPLÉMENT pour la confection des panneaux de tête de lit avec des tissus appartenant à d'autres catégories que le revêtement du lit (hors cuir).

+320



Cod. **PIE68 Madreperla**
H. 17

For additional cover see page. 19
Para funda adicional, consultar página. 19
Pour housse supplémentaire, voir p. 19

For bed bases see page 252 (price list 2023)
Para somier consultar página 252 (lista de precios 2023)
Pour les sommiers voir p. 252 (tarif 2023)

For the choice of mattress see page 235 (price list 2023)
Para la elección del colchón consultar página 235 (lista de precios 2023)
Pour le choix du matelas voir p. 235 (tarif 2023)

For other bed frames see the following page

Para otros aro de cama ver la página siguiente
Pour les autres cadres de lit, voir la page suivante



Bed frame H. 15 A- (without bed base)

Aro de cama H. 15 A- (sin somier)

Cadre de lit H. 15 A- (sans sommier)

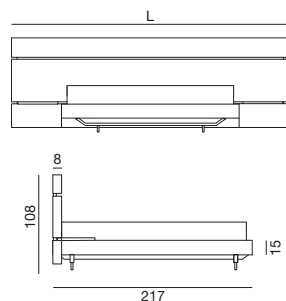

Bed base/ mattress size Medida de somier/colchón Mesure sommier/matelas	Bed code Código cama Code lit	H.L.P.	Fabrics - Telas - Tissu				Leather - Piel - Cuir			C.O.M. fabric L./H. Tela cliente Tissu client	m ³	kg	
			Cat. B	Cat. C/D	Cat. Must	Cat. K	Cat. E	Cat. Plus	Cat. Luxury				
193x203	16019KE3A	108x321x220	4.030	4.180	4.330	4.635	5.400	6.170	6.775	4.030	6,50/1,40	0,83	118
180x200	160185E3A	108x301x217	3.695	3.830	3.970	4.250	4.930	5.625	6.175	3.695	6,10/1,40	0,81	113
160x200	160165E3A	108x283x217	3.600	3.725	3.860	4.115	4.765	5.415	5.930	3.600	5,70/1,40	0,79	109
153x203	16015QE3A	108x283x220	3.655	3.790	3.915	4.180	4.820	5.470	5.995	3.655	5,70/1,40	0,79	109

Bed for bed base or mattress with length 190 cm, no extra charge.
Cama para somier o colchón largo 190 cm, sin recargo.
Lit pour sommier ou matelas profondeur 190 cm sans supplément.

**EXTRA CHARGE for customization of headboard panels.
Upholstered with fabric belonging to different categories form the bed cover (excluded leather).**

RECARGO para personalizar los paneles del cabecero de la cama.
Tapizado con telas pertenecientes a categorías distintas a la de cubrecamas (excluido cuero).
SUPPLÉMENT pour la confection des panneaux de tête de lit avec des tissus appartenant à d'autres catégories que le revêtement du lit (hors cuir).

+320

For additional cover see page. 19
Para funda adicional, consultar página. 19
Pour housse supplémentaire, voir p. 19

For bed bases see page 252 (price list 2023)
Para somier consultar página 252 (lista de precios 2023)
Pour les sommiers voir p. 252 (tarif 2023)

For the choice of mattress see page 235 (price list 2023)
Para la elección del colchón consultar página 235 (lista de precios 2023)
Pour le choix du matelas voir p. 235 (tarif 2023)

Bed frame H. 15 A-Box with storage (Ortopedic Plus bed base)

Aro de cama H. 15 A-Box con arcon

(Somier Ortopedic Plus)
Cadre de lit H. 15 A-Box avec coffre
(sommier Ortopedic Plus)

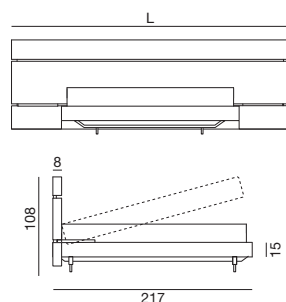

Bed base/ mattress size Medida de somier/colchón Mesure sommier/matelas	Bed code Código cama Code lit	H.L.P.	Fabrics - Telas - Tissu				Leather - Piel - Cuir			C.O.M. fabric L./H. Tela cliente Tissu client	m ³	kg	
			Cat. B	Cat. C/D	Cat. Must	Cat. K	Cat. E	Cat. Plus	Cat. Luxury				
193x203	16019KE3A KBTAB019K	108x321x220	5.505	5.655	5.805	6.110	6.875	7.645	8.250	5.505	6,50/1,40	1,33	218
180x200	160185E3A KBTAB0185	108x301x217	5.065	5.200	5.340	5.620	6.300	6.995	7.545	5.065	6,10/1,40	1,31	203
160x200	160165E3A KBTAB0165	108x283x217	4.905	5.030	5.165	5.420	6.070	6.720	7.235	4.905	5,70/1,40	1,29	194
153x203	16015QE3A KBTAB015Q	108x283x220	5.045	5.180	5.305	5.570	6.210	6.860	7.385	5.045	5,70/1,40	1,29	194

Bed for bed base or mattress with length 190 cm, no extra charge.
Cama para somier o colchón largo 190 cm, sin recargo.
Lit pour sommier ou matelas profondeur 190 cm sans supplément.

**EXTRA CHARGE for customization of headboard panels.
Upholstered with fabric belonging to different categories form the bed cover (excluded leather).**

RECARGO para personalizar los paneles del cabecero de la cama.
Tapizado con telas pertenecientes a categorías distintas a la de cubrecamas (excluido cuero).
SUPPLÉMENT pour la confection des panneaux de tête de lit avec des tissus appartenant à d'autres catégories que le revêtement du lit (hors cuir).

+320

For additional cover see page. 19
Para funda adicional, consultar página. 19
Pour housse supplémentaire, voir p. 19

For storage box with no standard bed base see page 25 (price list 2023)
Para arcon sin somier estándar consultar página 25 (lista de precios 2023)
Pour Coffre de rangement avec sommiers non standard voir p. 25 (tarif 2023)

For the choice of mattress see page 235 (price list 2023)
Para la elección del colchón consultar página 235 (lista de precios 2023)
Pour le choix du matelas voir p. 235 (tarif 2023)

Bed frame H. 25 without bed base

Aro de cama H. 25 sin somier

Cadre de lit H. 25 sans sommier

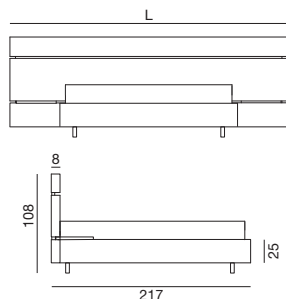

Bed base/ mattress size Medida de somier/colchón Mesure sommier/matelas	Bed code Código cama Code lit	H.L.P.	Fabrics - Telas - Tissu				Leather - Piel - Cuir			C.O.M. fabric L./H. Tela cliente Tissu client	m³	kg	
			Cat. B	Cat. C/D	Cat. Must	Cat. K	Cat. E	Cat. Plus	Cat. Luxury				
200x200	160205E7N	108x321x217	3.785	3.935	4.090	4.240	5.160	5.925	6.540	3.785	6,50/1,40	0,83	118
193x203	16019KE7N	108x321x220	3.785	3.935	4.090	4.240	5.160	5.925	6.540	3.785	6,50/1,40	0,83	118
180x200	160185E7N	108x301x217	3.535	3.675	3.815	3.945	4.775	5.465	6.015	3.535	6,10/1,40	0,81	113
170x200	160175E7N	108x301x217	3.535	3.675	3.815	3.945	4.775	5.465	6.015	3.535	6,10/1,40	0,81	113
160x200	160165E7N	108x283x217	3.430	3.565	3.690	3.820	4.595	5.245	5.760	3.430	5,70/1,40	0,79	109
153x203	16015QE7N	108x283x220	3.420	3.540	3.660	3.785	4.515	5.125	5.610	3.420	5,70/1,40	0,79	109

Bed for bed base or mattress with length 190 cm, no extra charge. With length 210 cm, extra charge (excluded dimensions 153x203 and 193x203)
Cama para somier o colchón largo 190 cm, sin recargo. Largo 210 cm, recargo (dimensiones excluidas 153x203 y 193x203)
Lit pour sommier ou matelas profondeur 190 cm sans supplément. Avec une profondeur de 210 cm, supplément (hors mesures 153x203 et 193x203)

+280

**EXTRA CHARGE for customization of headboard panels.
Upholstered with fabric belonging to different categories form the bed cover (excluded leather).**

RECARGO para personalizar los paneles del cabecero de la cama.

Tapizado con telas pertenecientes a categorías distintas a la de cubrecamas (excluido cuero).

SUPPLÉMENT pour la confection des panneaux de tête de lit avec des tissus appartenant à d'autres catégories que le revêtement du lit (hors cuir).

+320



Cod. **FLOAT SUITE (disappearing feet system) - (sistema de patas que desaparece) - (système de pieds disparaissants)**
H. 25

For additional cover see page. 19
Para funda adicional, consultar página. 19
Pour housse supplémentaire, voir p. 19

For bed bases see page 252 (price list 2023)
Para somier consultar página 252 (lista de precios 2023)
Pour les sommiers voir p. 252 (tarif 2023)

For the choice of mattress see page 235 (price list 2023)
Para la elección del colchón consultar página 235 (lista de precios 2023)
Pour le choix du matelas voir p. 235 (tarif 2023)

Bed frame H. 25 with storage (Ortopedic Plus bed base)

Aro de cama H. 25 con arcon
(Somier Ortopedic Plus)

Cadre de lit H. 25 avec coffre
(sommier Ortopedic Plus)

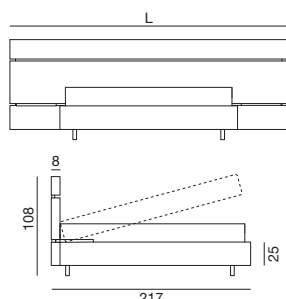

Bed base/ mattress size Medida de somier/colchón Mesure sommier/matelas	Bed code Código cama Code lit	H.L.P.	Fabrics - Telas - Tissu				Leather - Piel - Cuir			C.O.M. fabric L./H. Tela cliente Tissu client	m³	kg	
			Cat. B	Cat. C/D	Cat. Must	Cat. K	Cat. E	Cat. Plus	Cat. Luxury				
200x200	160205E7N KBT800205	108x321x217	5.075	5.225	5.380	5.530	6.450	7.215	7.830	5.075	6,50/1,40	1,33	178
193x203	16019KE7N KBT80019K	108x321x220	5.075	5.225	5.380	5.530	6.450	7.215	7.830	5.075	6,50/1,40	1,33	178
180x200	160185E7N KBT800185	108x301x217	4.525	4.665	4.805	4.935	5.765	6.455	7.005	4.525	6,10/1,40	1,31	173
170x200	160175E7N KBT800175	108x301x217	4.525	4.665	4.805	4.935	5.765	6.455	7.005	4.525	6,10/1,40	1,31	173
160x200	160165E7N KBT800165	108x283x217	4.300	4.435	4.560	4.690	5.465	6.115	6.630	4.300	5,70/1,40	1,29	169
153x203	16015QE7N KBT80015Q	108x283x220	4.290	4.410	4.530	4.655	5.385	5.995	6.480	4.290	5,70/1,40	1,29	169

Bed for bed base or mattress with length 190 cm, no extra charge. With length 210 cm, extra charge (excluded dimensions 153x203 and 193x203)
Cama para somier o colchón largo 190 cm, sin recargo. Largo 210 cm, recargo (dimensiones excluidas 153x203 y 193x203)
Lit pour sommier ou matelas profondeur 190 cm sans supplément. Avec une profondeur de 210 cm, supplément (hors mesures 153x203 et 193x203)

+280

**EXTRA CHARGE for customization of headboard panels.
Upholstered with fabric belonging to different categories form the bed cover (excluded leather).**

RECARGO para personalizar los paneles del cabecero de la cama.

Tapizado con telas pertenecientes a categorías distintas a la de cubrecamas (excluido cuero).

SUPPLÉMENT pour la confection des panneaux de tête de lit avec des tissus appartenant à d'autres catégories que le revêtement du lit (hors cuir).

+320



Cod. **FLOAT SUITE (disappearing feet system) - (sistema de patas que desaparece) - (système de pieds disparaissants)**
H. 25

For additional cover see page. 19
Para funda adicional, consultar página. 19
Pour housse supplémentaire, voir p. 19

For storage box with no standard bed base see page 25 (price list 2023)
Para arcon sin somier estándar consultar página 25 (lista de precios 2023)
Pour Coffre de rangement avec sommiers non standard voir p. 25 (tarif 2023)

For the choice of mattress see page 235 (price list 2023)
Para la elección del colchón consultar página 235 (lista de precios 2023)
Pour le choix du matelas voir p. 235 (tarif 2023)

Infinito Alto

Upholstered bed with bed frame H. 15 / 25

Cama tapizada con aro de cama H. 15 / 25

Lit rembourré avec cadre de lit H. 15 / 25

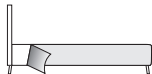

Removable cover

Funda desenfundable
Housse amovible



Prices difference from the standard feet

Diferencia de precios respecto a las patas estándar
Différence de prix par rapport au pied standard

In the leather version, the headboard and bed frame have one or more seams based on the size of the tanned leather

En la versión de piel, el cabecero y la estructura de la cama tienen una o más costuras según el tamaño del curtido
Dans la version cuir, la tête de lit et le cadre de lit ont une ou plusieurs coutures, selon la taille du tannage du cuir

		W	M	T	F	K	V	L	X	Z	H	B
		Bianco	Madreperla	Tortora	Fumo	Noce canaletto	Termocotto	Alluminio lucido	Brown Bronze	Grafite	Black nichel	Nero opaco
H. 15	PIE68											
	H. 17		0	0	0	0	0					
H. 25	FLOAT SUITE											
	H. 11											

Integrated dimmable light included in the price, with 2 radio control and magnet.

Luz integrada regulable incluida en el precio, con 2 radio control y magnético.

Lumière intégrée à intensité variable incluse dans le prix, avec 2 radiocommande et aimant.

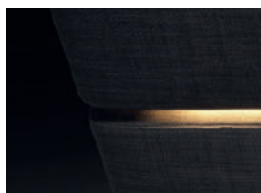

Wall panel with flush mounting box

Panel con caja de empotrar
Panneau avec boîte de dérivation

+ 115 Each
Cada - Chaque

Wifi on/off Room light control kit.

2 Bluetooth/Wifi Switches with Relay, compatible with the original wall switch. It allows you to remotely control the turning on of the room light, avoiding placing electrical cables on the headboard of the bed.

Kit de control de luz de habitación encendido/apagado WiFi.
2 Interruptores Bluetooth/Wifi con Relé, compatibles con el interruptor de pared original. Esto permite controlar de forma remota el encendido de las luces de la habitación, evitando colocar cables eléctricos en el cabecero de la cama.

Kit de contrôle de l'éclairage de la pièce marche/arrêt WiFi.
2 interrupteurs Bluetooth/WiFi avec relais, compatibles avec l'interrupteur mural d'origine. Cela permet de contrôler à distance l'allumage des lumières de la chambre sans avoir à faire passer des câbles électriques jusqu'à la tête de lit.

+ 200



Shelf finishes and prices see page 18

Aabados de estanterías y precios ver página 18
Finitions des étagères et prix voir page 18

Wood insert finishing

Acabado del inserto de madera
Finition insert en bois

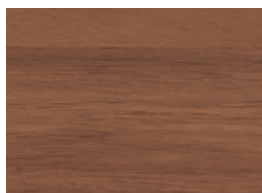

Noce canaletto

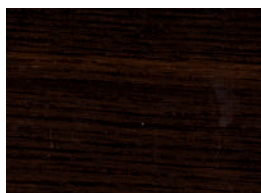

Termocotto

Painted insert finish

Acabado del inserto pintado
Finition insert laqué

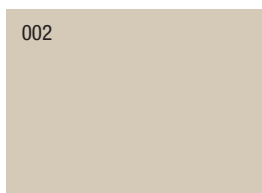

Canapa

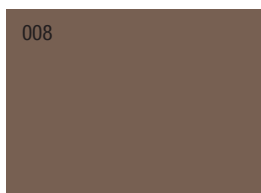

Visone

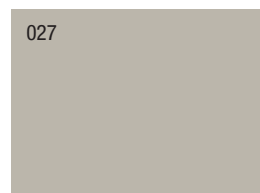

Juta

Available from January 2025

Disponible a partir de Enero de 2025
Disponible à partir de Janvier 2025



Bed frame H. 15 without bed base

Aro de cama H. 15 sin somier

Cadre de lit H. 15 sans sommier

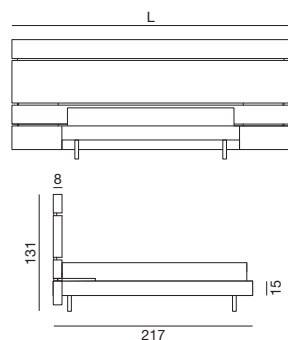

Bed base/ mattress size Medida de somier/colchón Mesure sommier/matelas	Bed code Código cama Code lit	H.L.P.	Fabrics - Telas - Tissu				Leather - Piel - Cuir			C.O.M. fabric L./H. Tela cliente Tissu client	m ³	kg	
			Cat. B	Cat. C/D	Cat. Must	Cat. K	Cat. E	Cat. Plus	Cat. Luxury				
200x200	15Z205E3I	131x 321 x217	4.115	4.305	4.490	4.870	5.815	6.755	7.510	4.115	9,50/1,40	0,93	133
193x203	15Z19KE3I	131x 321 x220	4.220	4.405	4.595	4.975	5.915	6.860	7.610	4.220	9,50/1,40	0,93	133
170x200	15Z185E3I	131x 301 x217	3.870	4.040	4.205	4.550	5.395	6.245	6.920	3.870	9,10/1,40	0,91	128
180x200	15Z175E3I	131x 301 x217	3.865	4.035	4.200	4.545	5.390	6.235	6.915	3.865	9,10/1,40	0,91	128
160x200	15Z165E3I	131x 283 x217	3.760	3.925	4.080	4.400	5.200	6.000	6.640	3.760	8,70/1,40	0,89	124
153x203	15Z15QE3I	131x 283 x220	3.795	3.940	4.090	4.395	5.145	5.895	6.500	3.795	8,70/1,40	0,89	124

Bed for bed base or mattress with length 190 cm, no extra charge. With length 210 cm, extra charge (excluded dimensions 153x203 and 193x203)
 Cama para somier o colchón largo 190 cm, sin recargo. Largo 210 cm, recargo (dimensiones excluidas 153x203 y 193x203)
 Lit pour sommier ou matelas profondeur 190 cm sans supplément. Avec une profondeur de 210 cm, supplément (hors mesures 153x203 et 193x203)

+280

**EXTRA CHARGE for customization of headboard panels.
 Upholstered with fabric belonging to different categories from the bed cover (excluded leather).**

RECARGO para personalizar los paneles del cabecero de la cama.

Tapizado con telas pertenecientes a categorías distintas a la de cubrecamas (excluido cuero).

SUPPLÉMENT pour la confection des panneaux de tête de lit avec des tissus appartenant à d'autres catégories que le revêtement du lit (hors cuir).

+320



Cod. **PIE68 Madreperla**
H. 17

For additional cover see page. 19
 Para funda adicional, consultar página. 19
 Pour housse supplémentaire, voir p. 19

For bed bases see page 252 (price list 2023)
 Para somier consultar página 252 (lista de precios 2023)
 Pour les sommiers voir p. 252 (tarif 2023)

For the choice of mattress see page 235 (price list 2023)
 Para la elección del colchón consultar página 235 (lista de precios 2023)
 Pour le choix du matelas voir p. 235 (tarif 2023)

For other bed frames see the following page

Para otros aro de cama ver la página siguiente
 Pour les autres cadres de lit, voir la page suivante



Bed frame H. 15 A- (without bed base)

Aro de cama H. 15 A- (sin somier)

Cadre de lit H. 15 A- (sans sommier)

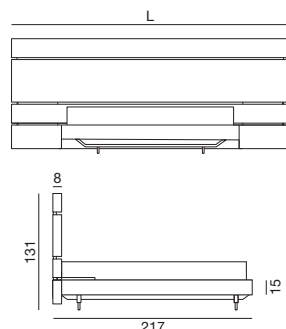

Bed base/ mattress size Medida de somier/colchón Mesure sommier/matelas	Bed code Código cama Code lit	H.L.P.	Fabrics - Telas - Tissu				Leather - Piel - Cuir			C.O.M. fabric L./H. Tela cliente Tissu client	m ³	kg	
			Cat. B	Cat. C/D	Cat. Must	Cat. K	Cat. E	Cat. Plus	Cat. Luxury				
193x203	15Z19KE3A	131x321x220	4.395	4.580	4.770	5.145	6.085	7.030	7.785	4.395	9,50/1,40	0,93	133
180x200	15Z185E3A	131x301x217	4.030	4.195	4.365	4.705	5.555	6.400	7.080	4.030	9,10/1,40	0,91	128
160x200	15Z165E3A	131x283x217	3.885	4.040	4.200	4.520	5.320	6.115	6.755	3.885	8,70/1,40	0,89	124
153x203	15Z15QE3A	131x283x220	3.975	4.140	4.295	4.615	5.415	6.215	6.850	3.975	8,70/1,40	0,89	124

Bed for bed base or mattress with length 190 cm, no extra charge.
Cama para somier o colchón largo 190 cm, sin recargo.
Lit pour sommier ou matelas profondeur 190 cm sans supplément.

**EXTRA CHARGE for customization of headboard panels.
Upholstered with fabric belonging to different categories form the bed cover (excluded leather).**

RECARGO para personalizar los paneles del cabecero de la cama.
Tapizado con telas pertenecientes a categorías distintas a la de cubrecamas (excluido cuero).
SUPPLÉMENT pour la confection des panneaux de tête de lit avec des tissus appartenant à d'autres catégories que le revêtement du lit (hors cuir).

+320

 For additional cover see page. 19
Para funda adicional, consultar página. 19
Pour housse supplémentaire, voir p. 19

 For bed bases see page 252 (price list 2023)
Para somier consultar página 252 (lista de precios 2023)
Pour les sommiers voir p. 252 (tarif 2023)

 For the choice of mattress see page 235 (price list 2023)
Para la elección del colchón consultar página 235 (lista de precios 2023)
Pour le choix du matelas voir p. 235 (tarif 2023)

Bed frame H. 15 A-Box with storage (Ortopedic Plus bed base)

Aro de cama H. 15 A-Box con arcon

(Somier Ortopedic Plus)
Cadre de lit H. 15 A-Box avec coffre
(sommier Ortopedic Plus)

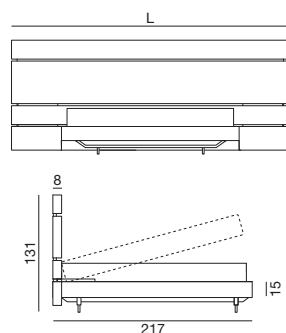

Bed base/ mattress size Medida de somier/colchón Mesure sommier/matelas	Bed code Código cama Code lit	H.L.P.	Fabrics - Telas - Tissu				Leather - Piel - Cuir			C.O.M. fabric L./H. Tela cliente Tissu client	m ³	kg	
			Cat. B	Cat. C/D	Cat. Must	Cat. K	Cat. E	Cat. Plus	Cat. Luxury				
193x203	15Z19KE3A KBTAB019K	131x321x220	5.870	6.055	6.245	6.620	7.560	8.505	9.260	5.870	9,50/1,40	1,43	233
180x200	15Z185E3A KBTAB0185	131x301x217	5.400	5.565	5.735	6.075	6.925	7.770	8.450	5.400	9,10/1,40	1,41	218
160x200	15Z165E3A KBTAB0165	131x283x217	5.190	5.345	5.505	5.825	6.625	7.420	8.060	5.190	8,70/1,40	1,39	209
153x203	15Z15QE3A KBTAB015Q	131x283x220	5.365	5.530	5.685	6.005	6.805	7.605	8.240	5.365	8,70/1,40	1,39	209

Bed for bed base or mattress with length 190 cm, no extra charge.
Cama para somier o colchón largo 190 cm, sin recargo.
Lit pour sommier ou matelas profondeur 190 cm sans supplément.

**EXTRA CHARGE for customization of headboard panels.
Upholstered with fabric belonging to different categories form the bed cover (excluded leather).**

RECARGO para personalizar los paneles del cabecero de la cama.
Tapizado con telas pertenecientes a categorías distintas a la de cubrecamas (excluido cuero).
SUPPLÉMENT pour la confection des panneaux de tête de lit avec des tissus appartenant à d'autres catégories que le revêtement du lit (hors cuir).

+320

 For additional cover see page. 19
Para funda adicional, consultar página. 19
Pour housse supplémentaire, voir p. 19

 For storage box with no standard bed base see page 25 (price list 2023)
Para arcon sin somier estándar consultar página 25 (lista de precios 2023)
Pour Coffre de rangement avec sommiers non standard voir p. 25 (tarif 2023)

 For the choice of mattress see page 235 (price list 2023)
Para la elección del colchón consultar página 235 (lista de precios 2023)
Pour le choix du matelas voir p. 235 (tarif 2023)

Bed frame H. 25 without bed base

Aro de cama H. 25 sin somier

Cadre de lit H. 25 sans sommier

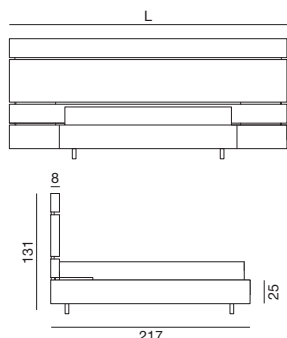

Bed base/ mattress size Medida de somier/colchón Mesure sommier/matelas	Bed code Código cama Code lit	H.L.P.	Fabrics - Telas - Tissu				Leather - Piel - Cuir			C.O.M. fabric L./H. Tela cliente Tissu client	m³	kg	
			Cat. B	Cat. C/D	Cat. Must	Cat. K	Cat. E	Cat. Plus	Cat. Luxury				
200x200	15Z205E7N	131x321x217	4.150	4.340	4.525	4.720	5.850	6.790	7.540	4.150	9,50/1,40	0,93	133
193x203	15Z19KE7N	131x321x220	4.150	4.340	4.525	4.720	5.850	6.790	7.540	4.150	9,50/1,40	0,93	133
180x200	15Z185E7N	131x301x217	3.865	4.040	4.205	4.375	5.390	6.245	6.920	3.865	9,10/1,40	0,91	128
170x200	15Z175E7N	131x301x217	3.865	4.040	4.205	4.375	5.390	6.245	6.920	3.865	9,10/1,40	0,91	128
160x200	15Z165E7N	131x283x217	3.750	3.910	4.070	4.230	5.190	5.980	6.620	3.750	8,70/1,40	0,89	124
153x203	15Z15QE7N	131x283x220	3.730	3.885	4.035	4.185	5.085	5.830	6.435	3.730	8,70/1,40	0,89	124

Bed for bed base or mattress with length 190 cm, no extra charge. With length 210 cm, extra charge (excluded dimensions 153x203 and 193x203)

Cama para somier o colchón largo 190 cm, sin recargo. Largo 210 cm, recargo (dimensiones excluidas 153x203 y 193x203)

Lit pour sommier ou matelas profondeur 190 cm sans supplément. Avec une profondeur de 210 cm, supplément (hors mesures 153x203 et 193x203)

+280

EXTRA CHARGE for customization of headboard panels.
Upholstered with fabric belonging to different categories form the bed cover (excluded leather).

RECARGO para personalizar los paneles del cabecero de la cama.

Tapizado con telas pertenecientes a categorías distintas a la de cubrecamas (excluido cuero).

SUPPLÉMENT pour la confection des panneaux de tête de lit avec des tissus appartenant à d'autres catégories que le revêtement du lit (hors cuir).

+320



Cod. **FLOAT SUITE (disappearing feet system) - (sistema de patas que desaparece) - (système de pieds disparaissants)**
H. 25

For additional cover see page. 19
 Para funda adicional, consultar página. 19
 Pour housse supplémentaire, voir p. 19

For bed bases see page 252 (price list 2023)
 Para somier consultar página 252 (lista de precios 2023)
 Pour les sommiers voir p. 252 (tarif 2023)

For the choice of mattress see page 235 (price list 2023)
 Para la elección del colchón consultar página 235 (lista de precios 2023)
 Pour le choix du matelas voir p. 235 (tarif 2023)

Bed frame H. 25 with storage (Ortopedic Plus bed base)

Aro de cama H. 25 con arcon

(Somier Ortopedic Plus)

Cadre de lit H. 25 avec coffre
 (sommier Ortopedic Plus)

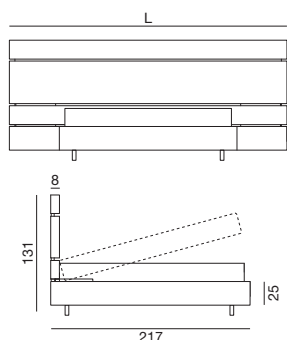

Bed base/ mattress size Medida de somier/colchón Mesure sommier/matelas	Bed code Código cama Code lit	H.L.P.	Fabrics - Telas - Tissu				Leather - Piel - Cuir			C.O.M. fabric L./H. Tela cliente Tissu client	m³	kg	
			Cat. B	Cat. C/D	Cat. Must	Cat. K	Cat. E	Cat. Plus	Cat. Luxury				
200x200	15Z205E7N KBT800205	131x321x217	5.440	5.630	5.815	6.010	7.140	8.080	8.830	5.440	9,50/1,40	1,43	193
193x203	15Z19KE7N KBT80019K	131x321x220	5.440	5.630	5.815	6.010	7.140	8.080	8.830	5.440	9,50/1,40	1,43	193
180x200	15Z185E7N KBT800185	131x301x217	4.855	5.030	5.195	5.365	6.380	7.235	7.910	4.855	9,10/1,40	1,41	188
170x200	15Z175E7N KBT800175	131x301x217	4.855	5.030	5.195	5.365	6.380	7.235	7.910	4.855	9,10/1,40	1,41	188
160x200	15Z165E7N KBT800165	131x283x217	4.620	4.780	4.940	5.100	6.060	6.850	7.490	4.620	8,70/1,40	1,39	184
153x203	15Z15QE7N KBT80015Q	131x283x220	4.600	4.755	4.905	5.055	5.955	6.700	7.305	4.600	8,70/1,40	1,39	184

Bed for bed base or mattress with length 190 cm, no extra charge. With length 210 cm, extra charge (excluded dimensions 153x203 and 193x203)

Cama para somier o colchón largo 190 cm, sin recargo. Largo 210 cm, recargo (dimensiones excluidas 153x203 y 193x203)

Lit pour sommier ou matelas profondeur 190 cm sans supplément. Avec une profondeur de 210 cm, supplément (hors mesures 153x203 et 193x203)

+280

EXTRA CHARGE for customization of headboard panels.
Upholstered with fabric belonging to different categories form the bed cover (excluded leather).

RECARGO para personalizar los paneles del cabecero de la cama.

Tapizado con telas pertenecientes a categorías distintas a la de cubrecamas (excluido cuero).

SUPPLÉMENT pour la confection des panneaux de tête de lit avec des tissus appartenant à d'autres catégories que le revêtement du lit (hors cuir).

+320



Cod. **FLOAT SUITE (disappearing feet system) - (sistema de patas que desaparece) - (système de pieds disparaissants)**
H. 25

For additional cover see page. 19
 Para funda adicional, consultar página. 19
 Pour housse supplémentaire, voir p. 19

For storage box with no standard bed base see page 25 (price list 2023)
 Para arcon sin somier estándar consultar página 25 (lista de precios 2023)
 Pour Coffre de rangement avec sommiers non standard voir p. 25 (tarif 2023)

For the choice of mattress see page 235 (price list 2023)
 Para la elección del colchón consultar página 235 (lista de precios 2023)
 Pour le choix du matelas voir p. 235 (tarif 2023)

Pouf infinito

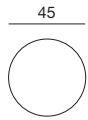
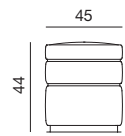

	Size Medida Mesure	Code Código Code	Fabrics - <i>Telas - Tissu</i>				Leather - <i>Piel - Cuir</i>			C.O.M. fabric L./H. <i>Tela cliente</i> Tissu client		m ³	kg
			Cat. B	Cat. C/D	Cat. Must	Cat. K	Cat. E	Cat. Plus	Cat. Luxury				
Foam <i>Espuma - Mousse</i>	Ø 45	41IX44H44	1.185	1.210	1.230	1.255	1.395	1.510	1.605	1.185	1,50/1,40	0,10	12

Insert available noce canaletto, termocotto, (from January 2025 available canapa, visone and juta finish as well).
Inserto disponible en noce canaletto, termocotto (a partir de Enero de 2025 disponible también acabados en canapa, visone y juta).
 Insert disponible en noce canaletto, termocotto (à partir de Janvier 2025 également en Canapa, Visone et Juta).

Not removable cover
Funda no desenfundable - Non déhoussable

Pouf infinito

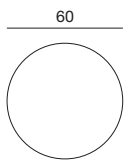
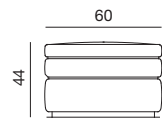

	Size Medida Mesure	Code Código Code	Fabrics - <i>Telas - Tissu</i>				Leather - <i>Piel - Cuir</i>			C.O.M. fabric L./H. <i>Tela cliente</i> Tissu client		m ³	kg
			Cat. B	Cat. C/D	Cat. Must	Cat. K	Cat. E	Cat. Plus	Cat. Luxury				
Foam <i>Espuma - Mousse</i>	Ø 60	41IX77H44	1.350	1.375	1.405	1.435	1.605	1.740	1.855	1.350	1,90/1,40	0,18	20

Insert available noce canaletto, termocotto, (from January 2025 available canapa, visone and juta finish as well).
Inserto disponible en noce canaletto, termocotto (a partir de Enero de 2025 disponible también acabados en canapa, visone y juta).
 Insert disponible en noce canaletto, termocotto (à partir de Janvier 2025 également en Canapa, Visone et Juta).

Not removable cover
Funda no desenfundable - Non déhoussable

Panchetta infinito

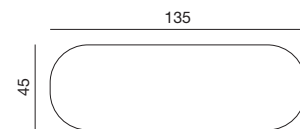
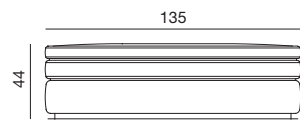

	Size Medida Mesure	Code Código Code	Fabrics - <i>Telas - Tissu</i>				Leather - <i>Piel - Cuir</i>			C.O.M. fabric L./H. <i>Tela cliente</i> Tissu client		m ³	kg
			Cat. B	Cat. C/D	Cat. Must	Cat. K	Cat. E	Cat. Plus	Cat. Luxury				
Foam <i>Espuma - Mousse</i>	135x45	41IX4FH44	2.280	2.315	2.350	2.385	2.595	2.770	2.910	2.280	3,35/1,40	0,27	40

Insert available noce canaletto, termocotto, (from January 2025 available canapa, visone and juta finish as well).
Inserto disponible en noce canaletto, termocotto (a partir de Enero de 2025 disponible también acabados en canapa, visone y juta).
 Insert disponible en noce canaletto, termocotto (à partir de Janvier 2025 également en Canapa, Visone et Juta).

Not removable cover
Funda no desenfundable - Non déhoussable

Mensola

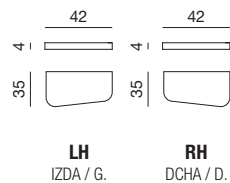

	Size Medida Mesure	Code Código Code	H.L.P.	Price each <i>Precio cada uno - Prix chacun</i>	m ³	kg
Noce canaletto	42x35 H4	425040M035		230	0,01	3
Termocotto	42x35 H4	425040M038		230	0,01	3
* Canapa	42x35 H4	425040M002		230	0,01	3
* Visone	42x35 H4	425040M008		230	0,01	3
* Juta	42x35 H4	425040M003		230	0,01	3

*** Available from January 2025**
Disponible a partir de Enero de 2025 - Disponible à partir de Janvier 2025



Bed covers

Fundas de cama - Housses du lit

Canalgrande



	Bed base size Medida de somier Mesure de Sommier	Cover code Código funda Code de housses	Fabrics - Telas - Tissu				Leather - Piel - Cuir			m ³	kg
			Cat. B	Cat. C/D	Cat. Must	Cat. K	Cat. E	Cat. Plus	Cat. Luxury		
Bed cover Funda de cama Housses du lit	193x203	A2419K6..	665	845	1.015	1.190	2.255	3.135	3.835	0,02	4
	180x200	A241856..	605	770	925	1.085	2.045	2.845	3.480	0,02	4
	160x200	A241656..	550	685	830	975	1.835	2.550	3.115	0,02	4
	153x203	A2415Q6..	550	685	830	975	1.835	2.550	3.115	0,02	4

Elle



	Bed base size Medida de somier Mesure de Sommier	Cover code Código funda Code de housses	Fabrics - Telas - Tissu				Leather - Piel - Cuir			m ³	kg
			Cat. B	Cat. C/D	Cat. Must	Cat. K	Cat. E	Cat. Plus	Cat. Luxury		
Bed cover Funda de cama Housses du lit	193x203	A4719KL1N	540	665	780	900	1.615	2.210	2.690	0,02	4
	180x200	A47185L1N	495	600	710	815	1.460	2.000	2.425	0,02	4
	160x200	A47165L1N	445	540	635	735	1.300	1.775	2.160	0,02	4
	153x203	A4715QL1N	445	540	635	735	1.300	1.775	2.160	0,02	4

Infinito basso



	Bed base size Medida de somier Mesure de Sommier	Cover code Código funda Code de housses	Fabrics - Telas - Tissu				Leather - Piel - Cuir			m ³	kg
			Cat. B	Cat. C/D	Cat. Must	Cat. K	Cat. E	Cat. Plus	Cat. Luxury		
Bed cover Funda de cama Housses du lit	200x200	A60205E..	755	905	1.060	1.215	2.130	2.895	3.505	0,02	4
	193x203	A6019KE..	755	905	1.060	1.215	2.130	2.895	3.505	0,02	4
	170x200	A60185E..	700	840	975	1.110	1.940	2.625	3.175	0,02	4
	180x200	A60175E..	700	840	975	1.110	1.940	2.625	3.175	0,02	4
	160x200	A60165E..	660	785	920	1.045	1.825	2.475	2.990	0,02	4
	153x203	A6015QE..	640	760	885	1.010	1.740	2.350	2.840	0,02	3

Infinito alto



	Bed base size Medida de somier Mesure de Sommier	Cover code Código funda Code de housses	Fabrics - Telas - Tissu				Leather - Piel - Cuir			m ³	kg
			Cat. B	Cat. C/D	Cat. Must	Cat. K	Cat. E	Cat. Plus	Cat. Luxury		
Bed cover Funda de cama Housses du lit	200x200	A5Z205E..	825	1.010	1.205	1.390	2.520	3.465	4.220	0,02	4
	193x203	A5Z19KE..	825	1.010	1.205	1.390	2.520	3.465	4.220	0,02	4
	170x200	A5Z185E..	760	930	1.105	1.275	2.290	3.135	3.815	0,02	4
	180x200	A5Z175E..	760	930	1.105	1.275	2.290	3.135	3.815	0,02	4
	160x200	A5Z165E..	715	880	1.035	1.195	2.155	2.955	3.595	0,02	4
	153x203	A5Z15QE..	700	850	1.000	1.150	2.050	2.805	3.400	0,02	3



Biggie FREESTYLE backrest
Respaldo Biggie FREESTYLE
Dossier Biggie FREESTYLE

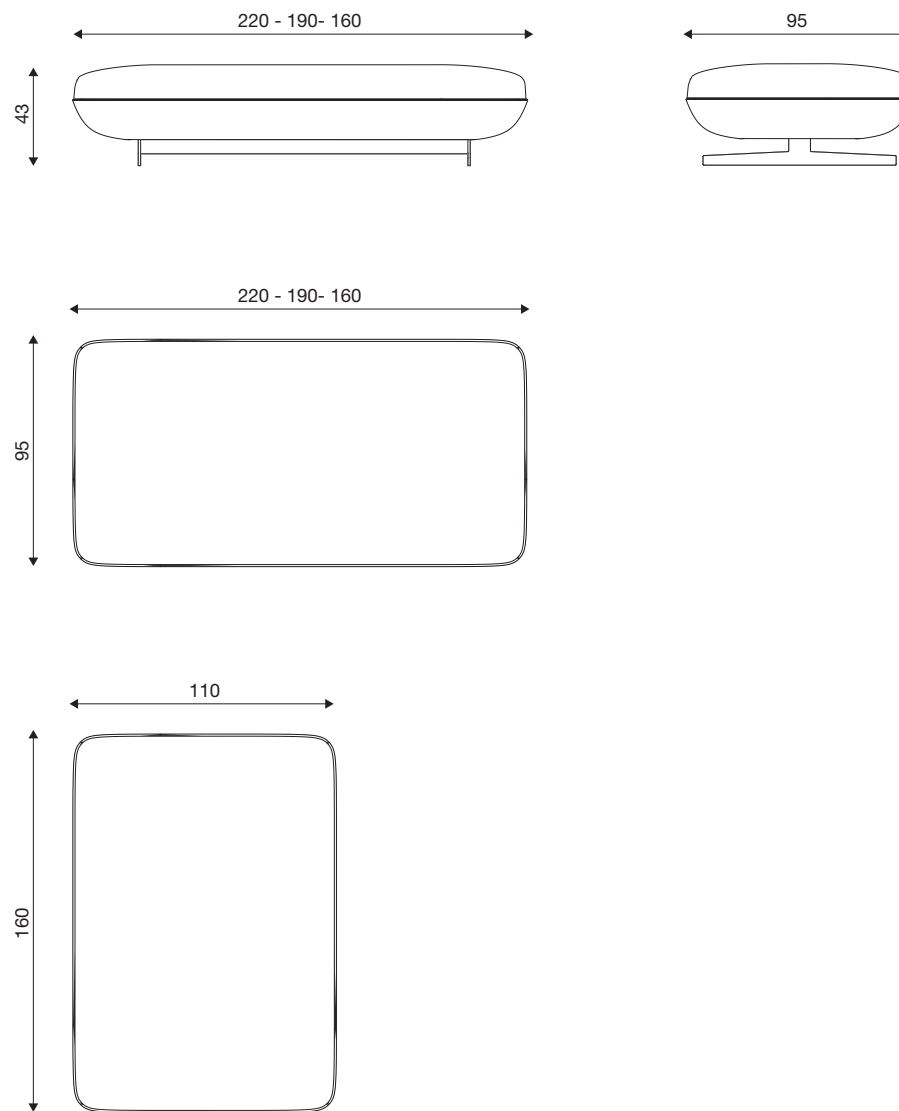

<p>Structure</p> <p>Baydur® polyurethane covered in 150 gr resin fibre. Baydur® is a very versatile firm polyurethane system. Thanks to its solidity it can be used for self-supporting structures.</p> <p>Seat cushion</p> <p>super soft polyurethane foam in different densities D40IP / D38IM</p> <p>Armrest and back cushions</p> <p>mixed of goose feather and polyester</p> <p>Backrest Cushion</p> <p>blend of goose feather and silicone fibre</p> <p>Panel</p> <p>multi-layer covered with non-woven fabric 100 gr</p> <p>Foot</p> <p>matt black painted metal</p>	<p><i>Estructura</i></p> <p><i>Poliuretano Baydur® recubierto de 150 gr. fibra de resina. Baydur® es un sistema de poliuretano rígido muy versátil. Gracias a su solidez se puede utilizar para estructuras autoportantes.</i></p> <p><i>Cojín del asiento</i></p> <p><i>espuma de poliuretano súper soft en diferentes densidades D40IP / D38IM</i></p> <p><i>Cojines brazos y respaldo</i></p> <p><i>mezcla pluma de ganso y poliéster</i></p> <p><i>Cojín del respaldo</i></p> <p><i>mezcla de pluma de ganso y fibra de silicona</i></p> <p><i>Multicapa</i></p> <p><i>recubierta de «tejido no tejido» 100 gr</i></p> <p><i>Patas</i></p> <p><i>metal pintado negro mate</i></p>	<p>Structure</p> <p>polyuréthane Baydur® recouvert de 150 gr. fibres de résine. Baydur® est un système de polyuréthane ferme très polyvalent. Grâce à sa solidité, il peut être utilisé pour des structures autoportantes.</p> <p>Coussin d'assise</p> <p>mousse de polyuréthane super douce de différentes densités D40IP / D38IM</p> <p>Coussins d'accoudoirs et de dossier</p> <p>mélange de plumes d'oie et de polyester</p> <p>Coussin de dossier</p> <p>mélange de duvet d'oie et de fibre de silicone</p> <p>Panneau multicouche</p> <p>100 g. avec interliner couplé</p> <p>Pieds</p> <p>en métal peint en noir mat</p>
<p>Completely removable cover (no leather)</p>	<p><i>Funda completamente desenfundable (no en piel)</i></p>	<p>Housse amovible (pas de cuir)</p>

Base

Base asiento

Base assise

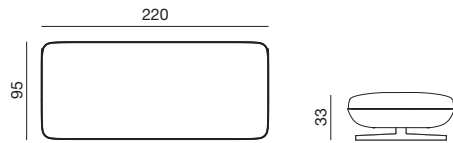

Description Descripción Description	Code Código Code	Size Medida Measure	Fabrics - Telas - Tissu				Leather - Piel - Cuir			C.O.M. fabric L./H. Tela cliente L./A. Tissu client L./H.
			Cat. B	Cat. C/D	Cat. Must	Cat. K	Cat. E	Cat. Plus	Cat. Luxury	
Sofa Sofá - Canapé	349CPON 220	220x95	-	3.555	3.690	3.825	4.655	5.345	5.895	-
Structure Estructura - Structure	349SEON 220		-	1.835	1.905	1.970	2.385	2.730	3.005	-
Cushions Cojines - Coussins	349UPON 220		-	1.720	1.785	1.855	2.270	2.615	2.890	-

m² 0,84 - kg. 176

Base

Base asiento

Base assise



Description Descripción Description	Code Código Code	Size Medida Measure	Fabrics - Telas - Tissu				Leather - Piel - Cuir			C.O.M. fabric L./H. Tela cliente L./A. Tissu client L./H.
			Cat. B	Cat. C/D	Cat. Must	Cat. K	Cat. E	Cat. Plus	Cat. Luxury	
Sofa Sofá - Canapé	349CPON 190	190x95	-	3.240	3.360	3.490	4.240	4.870	5.370	-
Structure Estructura - Structure	349SEON 190		-	1.675	1.735	1.800	2.175	2.490	2.740	-
Cushions Cojines - Coussins	349UPON 190		-	1.565	1.625	1.690	2.065	2.380	2.630	-

m² 0,72 - kg. 151

Base

Base asiento

Base assise

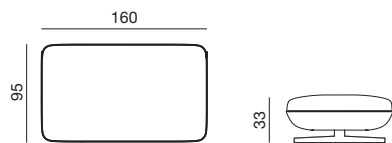

Description Descripción Description	Code Código Code	Size Medida Measure	Fabrics - Telas - Tissu				Leather - Piel - Cuir			C.O.M. fabric L./H. Tela cliente L./A. Tissu client L./H.
			Cat. B	Cat. C/D	Cat. Must	Cat. K	Cat. E	Cat. Plus	Cat. Luxury	
Sofa Sofá - Canapé	349CPON 160	160x95	-	2.985	3.085	3.185	3.790	4.285	4.690	-
Structure Estructura - Structure	349SEON 160		-	1.725	1.775	1.825	2.125	2.375	2.575	-
Cushions Cojines - Coussins	349UPON 160		-	1.260	1.310	1.360	1.665	1.910	2.115	-

m² 0,61 - kg. 126

Base

Base asiento

Base assise

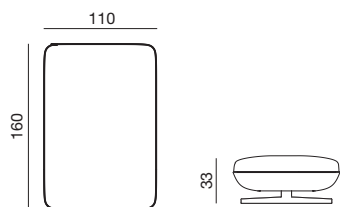

Description Descripción Description	Code Código Code	Size Medida Measure	Fabrics - Telas - Tissu				Leather - Piel - Cuir			C.O.M. fabric L./H. Tela cliente L./A. Tissu client L./H.
			Cat. B	Cat. C/D	Cat. Must	Cat. K	Cat. E	Cat. Plus	Cat. Luxury	
Sofa Sofá - Canapé	349CPON 110	160x110	-	3.255	3.365	3.485	4.180	4.765	5.225	-
Structure Estructura - Structure			-	1.800	1.855	1.915	2.265	2.555	2.785	-
Cushions Cojines - Coussins			-	1.455	1.510	1.570	1.915	2.210	2.440	-

m² 0,70 - kg. 88

Backrest

Respaldo

Dossier

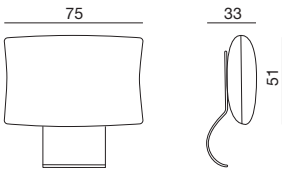

Description <i>Descripción</i> Description	Code <i>Código</i> Code	Size <i>Medida</i> Measure	Fabrics - <i>Telas</i> - Tissu				Leather - <i>Piel</i> - Cuir			C.O.M. fabric L./H. <i>Tela cliente L./A.</i> Tissu client L./H.
			Cat. B	Cat. C/D	Cat. Must	Cat. K	Cat. E	Cat. Plus	Cat. Luxury	
Cushions <i>Cojines</i> - Coussins	349EPBN		-	825	855	880	1.045	1.185	1.290	-

Structure finishing

Acabado ESTRUCTURA - Finition STRUCTURE



Noce canaletto

m³ 0,15 - kg. 20

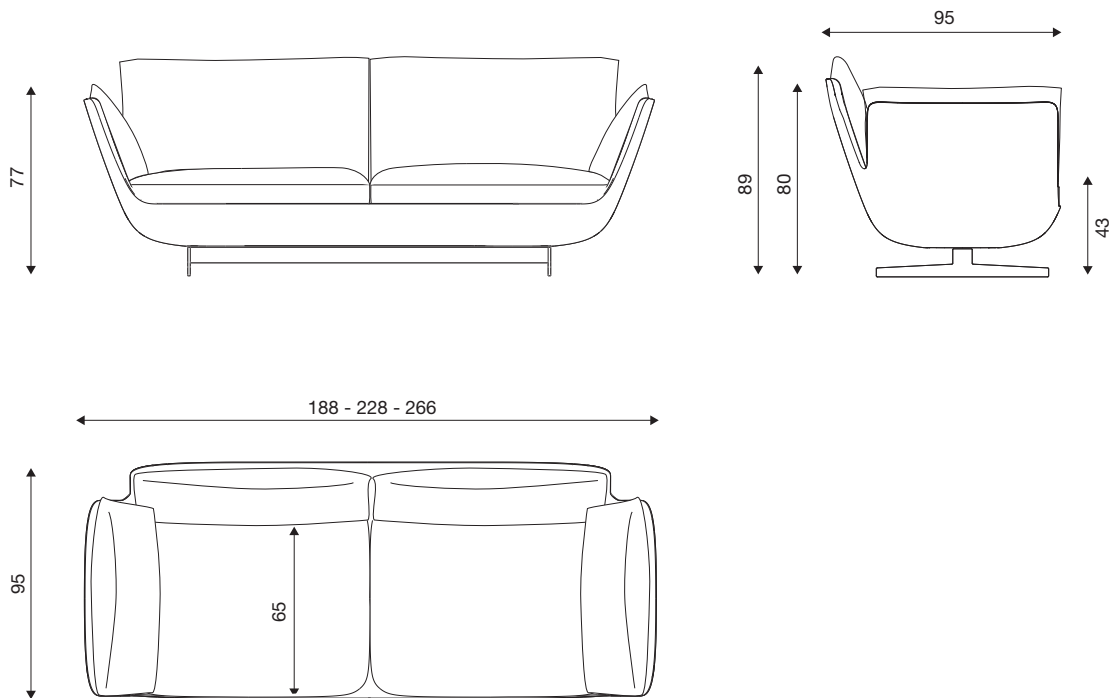

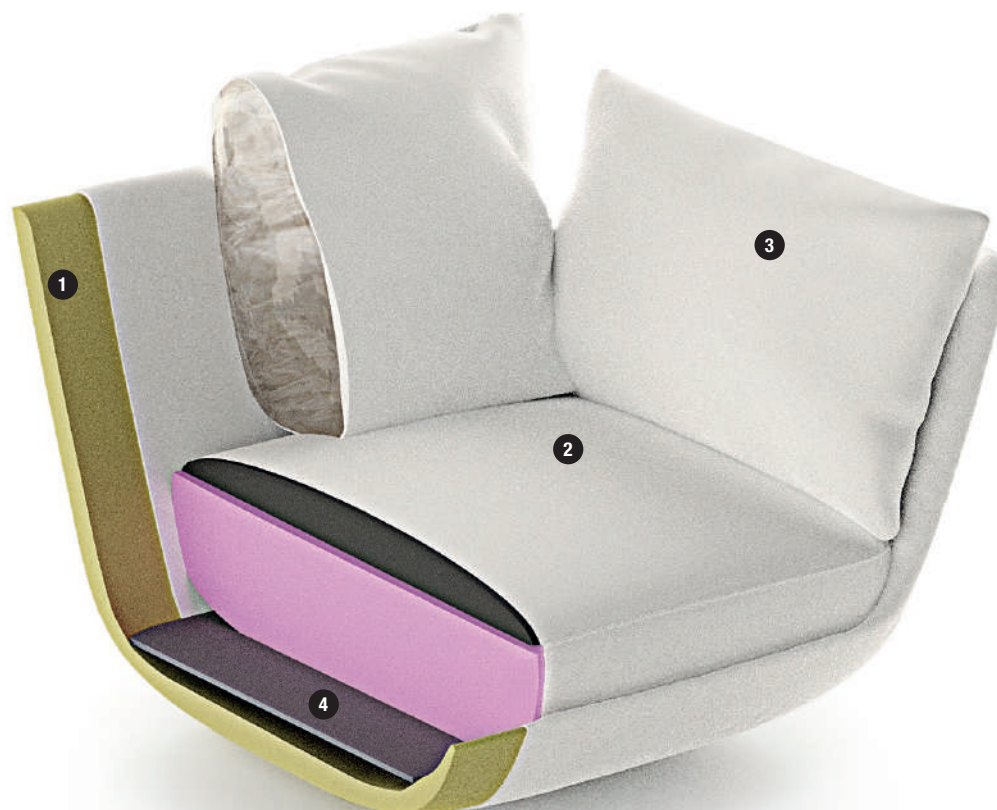

Completely removable cover (no leather)

Funda completamente desfundable (no en piel)

Housse amovible (pas de cuir)

- ❶ Structure: Baydur® polyurethane covered in 150 gr resin fibre. Baydur® is a very versatile firm polyurethane system. Thanks to its solidity it can be used for self-supporting structures.
- ❷ Seat cushion: super soft polyurethane foam in different densities D40IP / D38IM
- ❸ Armrest and back cushions: mixed of goose feather and polyester
- ❹ Multi-layer covered with non-woven fabric 100 gr

Metal feet black matt painted

- ❶ Estructura: Poliuretano Baydur® recubierto de 150 gr. fibra de resina. Baydur® es un sistema de poliuretano rígido muy versátil. Gracias a su solidez se puede utilizar para estructuras autoportantes.
- ❷ Cojín del asiento: espuma de poliuretano súper soft en diferentes densidades D40IP / D38IM
- ❸ Cojines brazos y respaldo: mezcla pluma de ganso y poliéster
- ❹ Multicapa recubierta de «tejido no tejido» 100 gr

Patas de metal pintado negro mate

- ❶ Structure: Polyuréthane Baydur® recouvert de 150 gr. fibres de résine. Baydur® est un système de polyuréthane ferme très polyvalent. Grâce à sa solidité, il peut être utilisé pour des structures autoportantes.
- ❷ Coussin d'assise: mousse de polyuréthane super douce de différentes densités D40IP / D38IM
- ❸ Coussins d'accoudoirs et de dossier: mélange de plumes d'oie et de polyester
- ❹ Panneau multicouche 100 g. avec interliner couplé.

Pieds en métal peint en noir mat

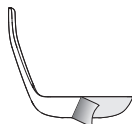

Not available in Cat. B

No disponible en Cat. B
Non faisable en Cat. B

Not available in C.O.M. fabric

No disponible en tela cliente
Non disponible dans le tissu du client



Not available in Cat. B

No disponible en Cat. B
Non faisable en Cat. B

Not available in C.O.M. fabric

No disponible en tela cliente
Non disponible dans le tissu du client

3 seaters Sofa max

Sofá de 3 plazas máximo

Canapé 3 places maximum

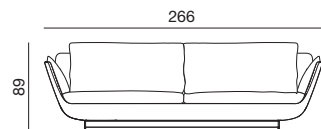

Description Descripción Description	Code Código Code	Size Medida Measure	Fabrics - <i>Telas</i> - Tissu				Leather - <i>Piel</i> - Cuir			C.O.M. fabric L./H. Tela cliente L./A. Tissu client L./H.
			Cat. B	Cat. C/D	Cat. Must	Cat. K	Cat. E	Cat. Plus	Cat. Luxury	
Sofa Sofá - Canapé	349CP1N 266	266x94	-	7.095	7.405	7.725	9.605	11.175	12.430	-
Structure Estructura - Structure	349ES1N 266		-	4.290	4.440	4.595	5.495	6.250	6.850	-
Cushions Cojines - Coussins	349UP1N 266		-	2.805	2.965	3.130	4.110	4.925	5.580	-

m³ 2,35 - kg. 130

3 seaters Sofa

Sofá de 3 plazas

Canapé 3 places

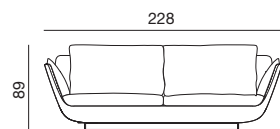

Description Descripción Description	Code Código Code	Size Medida Measure	Fabrics - <i>Telas</i> - Tissu				Leather - <i>Piel</i> - Cuir			C.O.M. fabric L./H. Tela cliente L./A. Tissu client L./H.
			Cat. B	Cat. C/D	Cat. Must	Cat. K	Cat. E	Cat. Plus	Cat. Luxury	
Sofa Sofá - Canapé	349CP1N 228	228x94	-	6.265	6.535	6.805	8.435	9.785	10.875	-
Structure Estructura - Structure	349ES1N 228		-	3.810	3.935	4.065	4.850	5.495	6.020	-
Cushions Cojines - Coussins	349UP1N 228		-	2.455	2.600	2.740	3.585	4.290	4.855	-

m³ 2,03 - kg. 112

2 seaters Sofa

Sofá de 2 plazas

Canapé 2 places

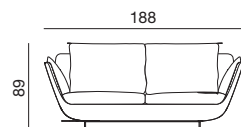

Description Descripción Description	Code Código Code	Size Medida Measure	Fabrics - <i>Telas</i> - Tissu				Leather - <i>Piel</i> - Cuir			C.O.M. fabric L./H. Tela cliente L./A. Tissu client L./H.
			Cat. B	Cat. C/D	Cat. Must	Cat. K	Cat. E	Cat. Plus	Cat. Luxury	
Sofa Sofá - Canapé	349CP1N 188	188x94	-	5.350	5.570	5.795	7.120	8.225	9.115	-
Structure Estructura - Structure	349ES1N 188		-	3.350	3.455	3.565	4.205	4.730	5.160	-
Cushions Cojines - Coussins	349UP1N 188		-	2.000	2.115	2.230	2.915	3.495	3.955	-

m³ 1,66 - kg. 93



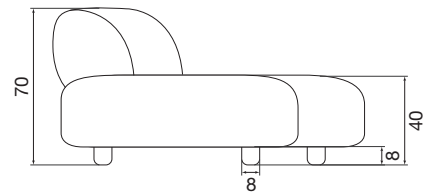
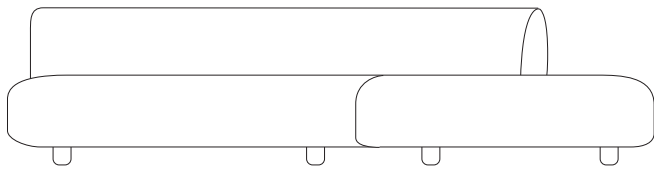

Structure	plywood and solid poplar and fir	<i>Estructura</i>	<i>contrachapado y macizo de álamo y abeto</i>	Structure	contreplaqué en bois et bois massif de sapin et de peuplier
Seat	polyurethane D35 IM MF D40	<i>Asiento</i>	<i>poliuretano D35 IM MF D40</i>	Assise	polyurethane D35 IM MF D40
Backrest:	polyurethane D35 IM MF D40	<i>Respaldo</i>	<i>poliuretano D35 IM MF D40</i>	Dossier	polyurethane D35 IM MF D40
Backrest cushion	blend of goose feather and silicone fibre	<i>Cojín del respaldo</i>	<i>mezcla de pluma de ganso y fibra de silicona</i>	Coussin de dossier	mélange de duvet d'oie et de fibre de silicone
Feet	wood	<i>Patas</i>	<i>madera</i>	Pieds	bois

Completely removable cover (no leather)

Funda completamente desenfundable (no en piel)

Housse amovible (pas de cuir)

Sofas

Sofás
Canapés

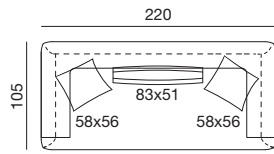

Description Descripción Description	Code Código Code	Side Lado Côté	Fabrics - <i>Telas</i> - Tissu				Leather - <i>Piel</i> - Cuir			C.O.M. fabric L./H. Tela cliente L./A. Tissu client L./H.
			Cat. B	Cat. C/D	Cat. Must	Cat. K	Cat. E	Cat. Plus	Cat. Luxury	
Foam <i>Espuma</i> - Mousse	34BCE1N 220		3.890	4.150	4.415	4.670	6.230	7.525	8.565	3.890 10,34/1,40
Cover <i>Revest.</i> - Housse.	C4BCE1N 220		865	1.125	1.390	1.645	-	-	-	865 10,34/1,40

m³ 1,82 - kg. 88

Sofas

Sofás
Canapés

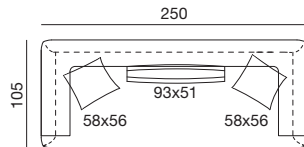

Description Descripción Description	Code Código Code	Side Lado Côté	Fabrics - <i>Telas</i> - Tissu				Leather - <i>Piel</i> - Cuir			C.O.M. fabric L./H. Tela cliente L./A. Tissu client L./H.
			Cat. B	Cat. C/D	Cat. Must	Cat. K	Cat. E	Cat. Plus	Cat. Luxury	
Foam <i>Espuma</i> - Mousse	34BCE1N 250		4.390	4.670	4.950	5.240	6.925	8.340	9.470	4.390 11,33/1,40
Cover <i>Revest.</i> - Housse.	C4BCE1N 250		925	1.205	1.485	1.775	-	-	-	925 11,33/1,40

m³ 2,06 - kg. 92

Sofas

Sofás
Canapés

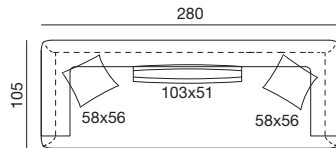

Description Descripción Description	Code Código Code	Side Lado Côté	Fabrics - <i>Telas</i> - Tissu				Leather - <i>Piel</i> - Cuir			C.O.M. fabric L./H. Tela cliente L./A. Tissu client L./H.
			Cat. B	Cat. C/D	Cat. Must	Cat. K	Cat. E	Cat. Plus	Cat. Luxury	
Foam <i>Espuma</i> - Mousse	34BCE1N 280		4.860	5.160	5.470	5.770	7.600	9.120	10.335	4.860 12,32/1,40
Cover <i>Revest.</i> - Housse	C4BCE1N 280		980	1.290	1.590	1.895	-	-	-	980 12,32/1,40

m³ 2,31 - kg. 96

Side element

Lateral
Éléments latéraux

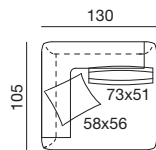

Description Descripción Description	Code Código Code	Side Lado Côté	Fabrics - <i>Telas</i> - Tissu				Leather - <i>Piel</i> - Cuir			C.O.M. fabric L./H. Tela cliente L./A. Tissu client L./H.
			Cat. B	Cat. C/D	Cat. Must	Cat. K	Cat. E	Cat. Plus	Cat. Luxury	
Foam <i>Espuma</i> - Mousse	34BCE2S 130	LH/IZDA/G.	2.695	2.855	3.020	3.180	4.140	4.940	5.580	2.695 6,27/1,40
	34BCE2R 130	RH/DCHA/D.								
Cover <i>Revest.</i> - Housse	C4BCE2S 130	LH/IZDA/G.	600	760	920	1.080	-	-	-	600 6,27/1,40
	C4BCE2R 130	RH/DCHA/D.								

LH / IZDA / G.

m³ 1,07 - kg. 75

Side element

Lateral
Éléments latéraux

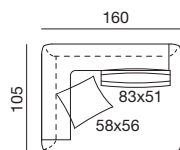

Description Descripción Description	Code Código Code	Side Lado Côté	Fabrics - <i>Telas</i> - Tissu				Leather - <i>Piel</i> - Cuir			C.O.M. fabric L./H. Tela cliente L./A. Tissu client L./H.
			Cat. B	Cat. C/D	Cat. Must	Cat. K	Cat. E	Cat. Plus	Cat. Luxury	
Foam <i>Espuma</i> - Mousse	34BCE2S 160	LH/IZDA/G.	3.020	3.210	3.390	3.570	4.665	5.580	6.310	3.020 7,26/1,40
	34BCE2R 160	RH/DCHA/D.								
Cover <i>Revest.</i> - Housse	C4BCE2S 160	LH/IZDA/G.	660	845	1.025	1.205	-	-	-	660 7,26/1,40
	C4BCE2R 160	RH/DCHA/D.								

LH / IZDA / G.

m³ 1,32 - kg. 78

Side element

Lateral

Éléments latéraux

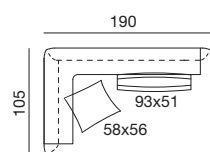

LH / IZDA / G.

Description Descripción Description	Code Código Code	Side Lado Côté	Fabrics - <i>Telas</i> - Tissu				Leather - <i>Piel</i> - Cuir			C.O.M. fabric L./H. <i>Tela cliente L./A.</i> Tissu client L./H.	
			Cat. B	Cat. C/D	Cat. Must	Cat. K	Cat. E	Cat. Plus	Cat. Luxury		
Foam <i>Espuma - Mousse</i>	34BCE2S 190 34BCE2R 190	LH / IZDA / G. RH / DCHA / D.	3.345	3.555	3.760	3.960	5.195	6.215	7.035	3.345	8,25/1,40
Cover <i>Revest. - Housse</i>	C4BCE2S 190 C4BCE2R 190	LH / IZDA / G. RH / DCHA / D.	715	925	1.130	1.335	-	-	-	715	8,25/1,40

m³ 1,57 - kg. 82

Side element

Lateral

Éléments latéraux

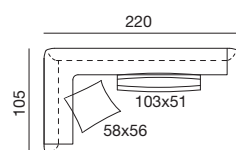

LH / IZDA / G.

Description Descripción Description	Code Código Code	Side Lado Côté	Fabrics - <i>Telas</i> - Tissu				Leather - <i>Piel</i> - Cuir			C.O.M. fabric L./H. <i>Tela cliente L./A.</i> Tissu client L./H.	
			Cat. B	Cat. C/D	Cat. Must	Cat. K	Cat. E	Cat. Plus	Cat. Luxury		
Foam <i>Espuma - Mousse</i>	34BCE2S 220 34BCE2R 220	LH / IZDA / G. RH / DCHA / D.	3.660	3.890	4.115	4.345	5.710	6.850	7.755	3.660	9,24/1,40
Cover <i>Revest. - Housse</i>	C4BCE2S 220 C4BCE2R 220	LH / IZDA / G. RH / DCHA / D.	780	1.005	1.235	1.460	-	-	-	780	9,24/1,40

m³ 1,82 - kg. 85

Central elements

Central

Chauffeuses

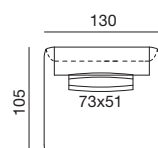

Description Descripción Description	Code Código Code	Side Lado Côté	Fabrics - <i>Telas</i> - Tissu				Leather - <i>Piel</i> - Cuir			C.O.M. fabric L./H. <i>Tela cliente L./A.</i> Tissu client L./H.	
			Cat. B	Cat. C/D	Cat. Must	Cat. K	Cat. E	Cat. Plus	Cat. Luxury		
Foam <i>Espuma - Mousse</i>	34BCE3N 130		2.250	2.360	2.475	2.595	3.275	3.845	4.300	2.250	4,73/1,40
Cover <i>Revest. - Housse</i>	C4BCE3N 130		460	570	685	800	-	-	-	460	4,73/1,40

m³ 1,07 - kg. 65

Central elements

Central

Chauffeuses

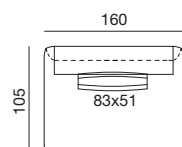

Description Descripción Description	Code Código Code	Side Lado Côté	Fabrics - <i>Telas</i> - Tissu				Leather - <i>Piel</i> - Cuir			C.O.M. fabric L./H. <i>Tela cliente L./A.</i> Tissu client L./H.	
			Cat. B	Cat. C/D	Cat. Must	Cat. K	Cat. E	Cat. Plus	Cat. Luxury		
Foam <i>Espuma - Mousse</i>	34BCE3N 160		2.705	2.835	2.970	3.110	3.930	4.610	5.155	2.705	5,72/1,40
Cover <i>Revest. - Housse</i>	C4BCE3N 160		515	650	790	925	-	-	-	515	5,72/1,40

m³ 1,32 - kg. 71

Central elements

Central

Chauffeuses

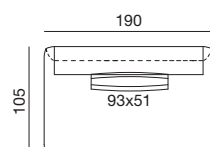

Description Descripción Description	Code Código Code	Side Lado Côté	Fabrics - <i>Telas</i> - Tissu				Leather - <i>Piel</i> - Cuir			C.O.M. fabric L./H. <i>Tela cliente L./A.</i> Tissu client L./H.	
			Cat. B	Cat. C/D	Cat. Must	Cat. K	Cat. E	Cat. Plus	Cat. Luxury		
Foam <i>Espuma - Mousse</i>	34BCE3N 190		3.020	3.175	3.335	3.495	4.450	5.245	5.875	3.020	6,71/1,40
Cover <i>Revest. - Housse</i>	C4BCE3N 190		570	730	890	1.045	-	-	-	570	6,71/1,40

m³ 1,57 - kg. 77

Central elements

Central
Chauffeuses

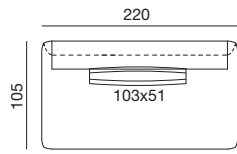

Description Descripción Description	Code Código Code	Side Lado Côté	Fabrics - Telas - Tissu				Leather - Piel - Cuir			C.O.M. fabric L./H. Tela cliente L./A. Tissu client L./H.	
			Cat. B	Cat. C/D	Cat. Must	Cat. K	Cat. E	Cat. Plus	Cat. Luxury		
Foam Espuma - Mousse	34BCE3N 220		3.335	3.515	3.700	3.880	4.970	5.870	6.595	3.335	7,70/1,40
Cover Revest. - Housse	C4BCE3N 220		630	810	990	1.175	-	-	-	630	7,70/1,40

m³ 1,82 - kg. 82

Corner

Ángulo
Élément d'angle

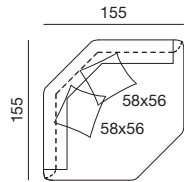

Description Descripción Description	Code Código Code	Side Lado Côté	Fabrics - Telas - Tissu				Leather - Piel - Cuir			C.O.M. fabric L./H. Tela cliente L./A. Tissu client L./H.	
			Cat. B	Cat. C/D	Cat. Must	Cat. K	Cat. E	Cat. Plus	Cat. Luxury		
Foam Espuma - Mousse	34BCE4N 155		3.750	3.920	4.095	4.265	5.310	6.180	6.870	3.750	6,27/1,40
Cover Revest. - Housse	C4BCE4N 155		655	825	1.005	1.180				655	6,27/1,40

m³ 1,86 - kg. 82

Chaise longues

Chaise longues - Chaise Longue

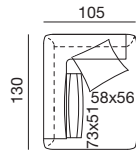

Description Descripción Description	Code Código Code	Side Lado Côté	Fabrics - Telas - Tissu				Leather - Piel - Cuir			C.O.M. fabric L./H. Tela cliente L./A. Tissu client L./H.	
			Cat. B	Cat. C/D	Cat. Must	Cat. K	Cat. E	Cat. Plus	Cat. Luxury		
Foam Espuma - Mousse	34BCE5S 130	LH / IZDA / G.	2.695	2.855	3.020	3.180	4.140	4.940	5.580	2.695	6,27/1,40
	34BCE5R 130	RH / DCHA / D.									
Cover Revest. - Housse	C4BCE5S 130	LH / IZDA / G.	600	760	920	1.080	-	-	-	600	6,27/1,40
	C4BCE5R 130	RH / DCHA / D.									

LH / IZDA / G.

m³ 1,07 - kg. 75

Chaise longues

Chaise longues - Chaise Longue

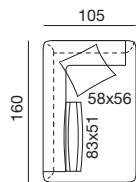

Description Descripción Description	Code Código Code	Side Lado Côté	Fabrics - Telas - Tissu				Leather - Piel - Cuir			C.O.M. fabric L./H. Tela cliente L./A. Tissu client L./H.	
			Cat. B	Cat. C/D	Cat. Must	Cat. K	Cat. E	Cat. Plus	Cat. Luxury		
Foam Espuma - Mousse	34BCE5S 160	LH / IZDA / G.	3.020	3.210	3.390	3.570	4.665	5.580	6.310	3.020	7,26/1,40
	34BCE5R 160	RH / DCHA / D.									
Cover Revest. - Housse	C4BCE5S 160	LH / IZDA / G.	660	845	1.025	1.205	-	-	-	660	7,26/1,40
	C4BCE5R 160	RH / DCHA / D.									

LH / IZDA / G.

m³ 1,32 - kg. 78

Chaise longues

Chaise longues - Chaise Longue

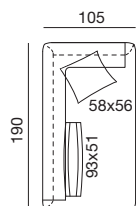

Description Descripción Description	Code Código Code	Side Lado Côté	Fabrics - Telas - Tissu				Leather - Piel - Cuir			C.O.M. fabric L./H. Tela cliente L./A. Tissu client L./H.	
			Cat. B	Cat. C/D	Cat. Must	Cat. K	Cat. E	Cat. Plus	Cat. Luxury		
Foam Espuma - Mousse	34BCE5S 190	LH / IZDA / G.	3.345	3.555	3.760	3.960	5.195	6.215	7.035	3.345	8,25/1,40
	34BCE5R 190	RH / DCHA / D.									
Cover Revest. - Housse	C4BCE5S 190	LH / IZDA / G.	715	925	1.130	1.335	-	-	-	715	8,25/1,40
	C4BCE5R 190	RH / DCHA / D.									

LH / IZDA / G.

m³ 1,57 - kg. 82

Chaise longues

Chaise longues - Chaise Longue

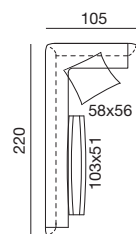

Description Descripción Description	Code Código Code	Side Lado Côté	Fabrics - <i>Telas</i> - Tissu				Leather - <i>Piel</i> - Cuir			C.O.M. fabric L./H. Tela cliente L./A. Tissu client L./H.
			Cat. B	Cat. C/D	Cat. Must	Cat. K	Cat. E	Cat. Plus	Cat. Luxury	
Foam <i>Espuma</i> - Mousse	34BCE5S 220 34BCE5R 220	LH/IZDA/G. RH/DCHA/D.	3.755	3.980	4.210	4.435	5.800	6.940	7.845	3.755 9,24/1,40
Cover <i>Revest.</i> - Housse	C4BCE5S 220 C4BCE5R 220	LH/IZDA/G. RH/DCHA/D.	780	1.005	1.235	1.460	-	-	-	780 9,24/1,40

LH / IZDA / G.

m³ 1,82 - kg. 85

Chaise longues

Chaise longues - Chaise Longue

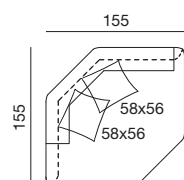

Description Descripción Description	Code Código Code	Side Lado Côté	Fabrics - <i>Telas</i> - Tissu				Leather - <i>Piel</i> - Cuir			C.O.M. fabric L./H. Tela cliente L./A. Tissu client L./H.
			Cat. B	Cat. C/D	Cat. Must	Cat. K	Cat. E	Cat. Plus	Cat. Luxury	
Foam <i>Espuma</i> - Mousse	34BCE5S 155 34BCE5R 155	LH/IZDA/G. RH/DCHA/D.	3.750	3.920	4.095	4.265	5.310	6.180	6.870	3.750 7,15/1,40
Cover <i>Revest.</i> - Housse	C4BCE5S 155 C4BCE5R 155	LH/IZDA/G. RH/DCHA/D.	655	825	1.005	1.180	-	-	-	655 7,15/1,40

LH / IZDA / G.

m³ 1,86 - kg. 82

Dormeuse with armrest

Meridienne con brazo

Meridienne avec accoudoir

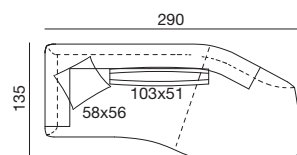

Description Descripción Description	Code Código Code	Side Lado Côté	Fabrics - <i>Telas</i> - Tissu				Leather - <i>Piel</i> - Cuir			C.O.M. fabric L./H. Tela cliente L./A. Tissu client L./H.
			Cat. B	Cat. C/D	Cat. Must	Cat. K	Cat. E	Cat. Plus	Cat. Luxury	
Foam <i>Espuma</i> - Mousse	34BCE7R 290 34BCE7S 290	LH/IZDA/G. RH/DCHA/D.	5.105	5.365	5.625	5.880	7.440	8.735	9.775	5.105 8,80/1,40
Cover <i>Revest.</i> - Housse	C4BCE7R 290 C4BCE7R 290	LH/IZDA/G. RH/DCHA/D.	880	1.140	1.400	1.660	-	-	-	880 8,80/1,40

m³ 3,05 - kg. 96

Dormeuse

Meridienne

Mériidienne

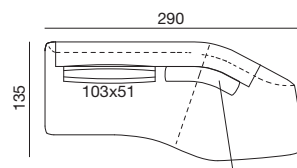
LUMBAR SUPPORT - SOPORTE LUMBAR - COUSSIN LOMBAIRE
65x35

Description Descripción Description	Code Código Code	Side Lado Côté	Fabrics - <i>Telas</i> - Tissu				Leather - <i>Piel</i> - Cuir			C.O.M. fabric L./H. Tela cliente L./A. Tissu client L./H.
			Cat. B	Cat. C/D	Cat. Must	Cat. K	Cat. E	Cat. Plus	Cat. Luxury	
Foam <i>Espuma</i> - Mousse	34BCE6R 290 34BCE6S 290	LH/IZDA/G. RH/DCHA/D.	4.640	4.830	5.030	5.220	6.395	7.365	8.140	4.640 9,90/1,40
Cover <i>Revest.</i> - Housse	C4BCE6R 290 C4BCE6R 290	LH/IZDA/G. RH/DCHA/D.	725	920	1.115	1.305	-	-	-	725 9,90/1,40

m³ 3,05 - kg. 100

Footstool

Puff

Pouf

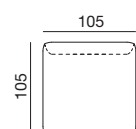

Description Descripción Description	Code Código Code	Side Lado Côté	Fabrics - <i>Telas</i> - Tissu				Leather - <i>Piel</i> - Cuir			C.O.M. fabric L./H. Tela cliente L./A. Tissu client L./H.
			Cat. B	Cat. C/D	Cat. Must	Cat. K	Cat. E	Cat. Plus	Cat. Luxury	
Foam <i>Espuma</i> - Mousse	34BCE8N 105	LH/IZDA/G. RH/DCHA/D.	1.345	1.410	1.480	1.555	1.975	2.330	2.610	1.345 3,52/1,40
Cover <i>Revest.</i> - Housse	C4BCE8N 105	LH/IZDA/G. RH/DCHA/D.	275	350	420	485	-	-	-	275 3,52/1,40

m³ 0,46 - kg. 45

Footstool

Puff
Pouf

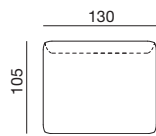

Description Descripción Description	Code Código Code	Side Lado Côté	Fabrics - <i>Telas</i> - Tissu				Leather - <i>Piel</i> - Cuir			C.O.M. fabric L./H. <i>Tela cliente L./A.</i> Tissu client L./H.	
			Cat. B	Cat. C/D	Cat. Must	Cat. K	Cat. E	Cat. Plus	Cat. Luxury		
Foam <i>Espuma</i> - Mousse	34BCE8N 130	LH / IZDA / G. RH / DCHA / D.	1.585	1.660	1.730	1.800	2.225	2.575	2.855	1.585	4,73/1,40
Cover <i>Revest.</i> - Housse	C4BCE8N 130	LH / IZDA / G. RH / DCHA / D.	290	360	430	505	-	-	-	290	4,73/1,40

m³ 0,57 - kg. 50

Back cushions

Respaldo de apoyo
Coussins de dossier

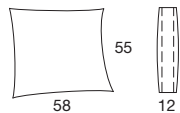

Description Descripción Description	Code Código Code	Size Medida Mesure	Fabrics - <i>Telas</i> - Tissu				Leather - <i>Piel</i> - Cuir			C.O.M. fabric L./H. <i>Tela cliente L./A.</i> Tissu client L./H.	
			Cat. B	Cat. C/D	Cat. Must	Cat. K	Cat. E	Cat. Plus	Cat. Luxury		
Feather <i>Pluma</i> - Plume	35FEPBN 058	58x56	160	180	200	220	325	420	490	160	7,00/1,40
Cover <i>Revest.</i> - Housse	C5FEEBN 058	58x56	70	85	100	110	-	-	-	70	7,00/1,40

m³ 0,05 - kg. 2

Back cushions

Respaldo de apoyo
Coussins de dossier

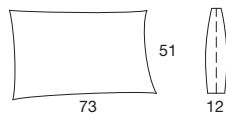

Description Descripción Description	Code Código Code	Size Medida Mesure	Fabrics - <i>Telas</i> - Tissu				Leather - <i>Piel</i> - Cuir			C.O.M. fabric L./H. <i>Tela cliente L./A.</i> Tissu client L./H.	
			Cat. B	Cat. C/D	Cat. Must	Cat. K	Cat. E	Cat. Plus	Cat. Luxury		
Feather <i>Pluma</i> - Plume	35FEPCN 073	73x51	185	200	220	245	360	465	545	185	9,00/1,40
Cover <i>Revest.</i> - Housse	C5FEECN 073	73x51	75	90	105	125	-	-	-	65	9,00/1,40

m³ 0,08 - kg. 3

Back cushions

Respaldo de apoyo
Coussins de dossier

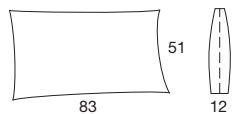

Description Descripción Description	Code Código Code	Size Medida Mesure	Fabrics - <i>Telas</i> - Tissu				Leather - <i>Piel</i> - Cuir			C.O.M. fabric L./H. <i>Tela cliente L./A.</i> Tissu client L./H.	
			Cat. B	Cat. C/D	Cat. Must	Cat. K	Cat. E	Cat. Plus	Cat. Luxury		
Feather <i>Pluma</i> - Plume	35FEPCN 083	83x51	190	210	240	265	395	505	590	190	10,00/1,40
Cover <i>Revest.</i> - Housse	C5FEECN 083	83x51	80	95	120	135	-	-	-	70	10,00/1,40

m³ 0,09 - kg. 3

Back cushions

Respaldo de apoyo
Coussins de dossier

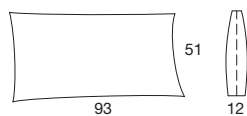

Description Descripción Description	Code Código Code	Size Medida Mesure	Fabrics - <i>Telas</i> - Tissu				Leather - <i>Piel</i> - Cuir			C.O.M. fabric L./H. <i>Tela cliente L./A.</i> Tissu client L./H.	
			Cat. B	Cat. C/D	Cat. Must	Cat. K	Cat. E	Cat. Plus	Cat. Luxury		
Feather <i>Pluma</i> - Plume	35FEPCN 093	93x51	200	220	250	275	410	525	620	200	11,00/1,40
Cover <i>Revest.</i> - Housse	C5FEECN 093	93x51	85	105	130	145	-	-	-	75	11,00/1,40

m³ 0,10 - kg. 3

Back cushions

Respaldo de apoyo
Coussins de dossier

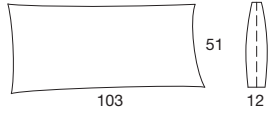

Description Descripción Description	Code Código Code	Size Medida Measure	Fabrics - <i>Telas</i> - Tissu				Leather - <i>Piel</i> - Cuir			C.O.M. fabric L./H. Tela cliente L./A. Tissu client L./H.	
			Cat. B	Cat. C/D	Cat. Must	Cat. K	Cat. E	Cat. Plus	Cat. Luxury		
Feather <i>Pluma</i> - Plume	35FEPCN 103	103x51	210	235	260	290	425	545	640	210	12,00/1,40
Cover <i>Revest.</i> - Housse	C5FEECN 103	103x51	90	110	135	155	-	-	-	80	12,00/1,40

m³ 0,11 - kg. 4

Lumbar support

Soporte lumbar
Coussin lombaire

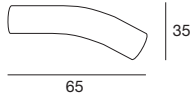

Description Descripción Description	Code Código Code	Size Medida Measure	Fabrics - <i>Telas</i> - Tissu				Leather - <i>Piel</i> - Cuir			C.O.M. fabric L./H. Tela cliente L./A. Tissu client L./H.	
			Cat. B	Cat. C/D	Cat. Must	Cat. K	Cat. E	Cat. Plus	Cat. Luxury		
Feather <i>Pluma</i> - Plume	34BEPEN 065	65x35	190	210	240	265	435	505	590	-	9,00/1,40
Cover <i>Revest.</i> - Housse	C4BEPEN 065	65x35	-	-	-	-	-	-	-	-	9,00/1,40

m³ 0,08 - kg. 2

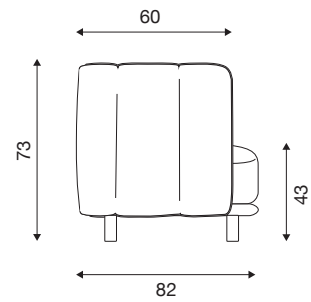
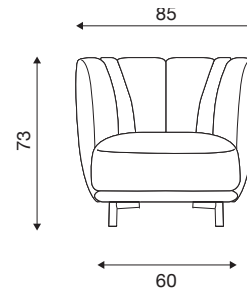
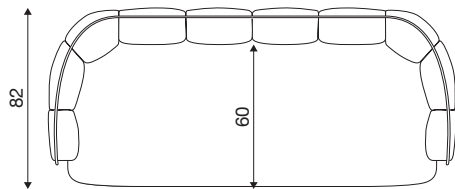
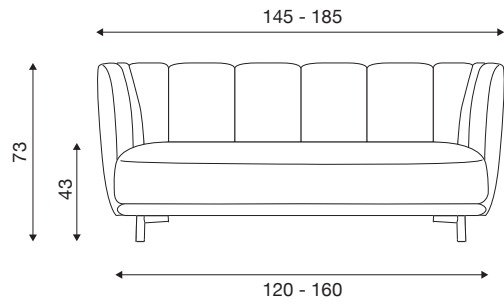

Structure	<i>Estructura</i>	Structure
polyester fibre	<i>fibra de poliéster</i>	fibre de polyester
polyurethane D40 IM	<i>poliuretano D40 IM</i>	polyurethane D40 IM
polyurethane D35 IM	<i>poliuretano D35 IM</i>	polyurethane D35 IM
polyurethane D30 IM	<i>poliuretano o D30 IM</i>	polyurethane D30 IM
polyurethane D35 IM elast	<i>poliuretano D35 IM elast</i>	polyurethane D35 IM elast
polyester fibre 150 gr	<i>fibra de poliéster 150 gr</i>	fibre de polyester 150 gr
plywood and solid poplar and fir	<i>madera contrachapada maciza</i>	contreplaqué en bois et bois massif de sapin
wood fibre	<i>de álamo y abeto</i>	et de peuplier
Feet	<i>Patas</i>	fibre de bois
wood colour termocotto	<i>color madera termocotto</i>	Pieds
		bois coluleur termocotto

Completely removable cover

Funda completamente desenfundable

Housse amovible

3 seaters Sofa

Sofá de 3 plazas

Canapé 3 places

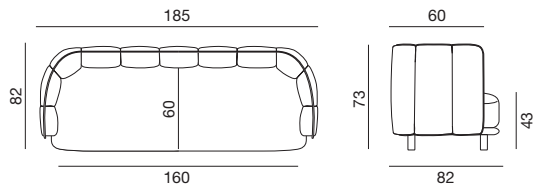

Description Descripción Description	Code Código Code	Side Lado Côté	Fabrics - <i>Telas</i> - Tissu				Leather - <i>Piel</i> - Cuir			C.O.M. fabric L./H. Tela cliente L./A. Tissu client L./H.	
			Cat. B	Cat. C/D	Cat. Must	Cat. K	Cat. E	Cat. Plus	Cat. Luxury		
Foam <i>Espuma</i> - Mousse	34DCE1N 185		3.300	3.465	3.630	3.795	4.785	5.610	6.270	3.300	8,50/1,40
Cover <i>Revest.</i> - Housse	C4DCE1N 185		905	1.070	1.235	1.400	2.390	3.215	3.875	905	8,50/1,40

m³ 1 - kg. 50

2 seaters Sofa

Sofá de 2 plazas

Canapé 2 places

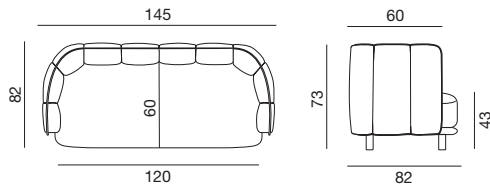

Description Descripción Description	Code Código Code	Side Lado Côté	Fabrics - <i>Telas</i> - Tissu				Leather - <i>Piel</i> - Cuir			C.O.M. fabric L./H. Tela cliente L./A. Tissu client L./H.	
			Cat. B	Cat. C/D	Cat. Must	Cat. K	Cat. E	Cat. Plus	Cat. Luxury		
Foam <i>Espuma</i> - Mousse	34DCE1N 145		3.115	3.270	3.425	3.575	4.500	5.270	5.885	3.115	9,10/1,40
Cover <i>Revest.</i> - Housse	C4DCE1N 145		880	1.035	1.190	1.345	2.270	3.040	3.655	880	9,10/1,40

m³ 1,2 - kg. 60

Armchair

Sillón

Fauteuil

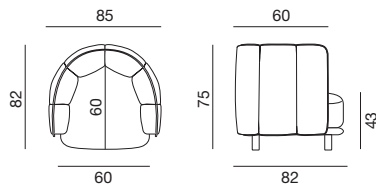

Description Descripción Description	Code Código Code	Side Lado Côté	Fabrics - <i>Telas</i> - Tissu				Leather - <i>Piel</i> - Cuir			C.O.M. fabric L./H. Tela cliente L./A. Tissu client L./H.	
			Cat. B	Cat. C/D	Cat. Must	Cat. K	Cat. E	Cat. Plus	Cat. Luxury		
Foam <i>Espuma</i> - Mousse	34DCEPN		1.950	2.020	2.100	2.170	2.610	2.970	3.270	1.950	4,25/1,40
Cover <i>Revest.</i> - Housse	C4DCEPN		530	605	685	760	1.225	1.610	1.915	530	4,25/1,40

m³ 0,6 - kg. 35



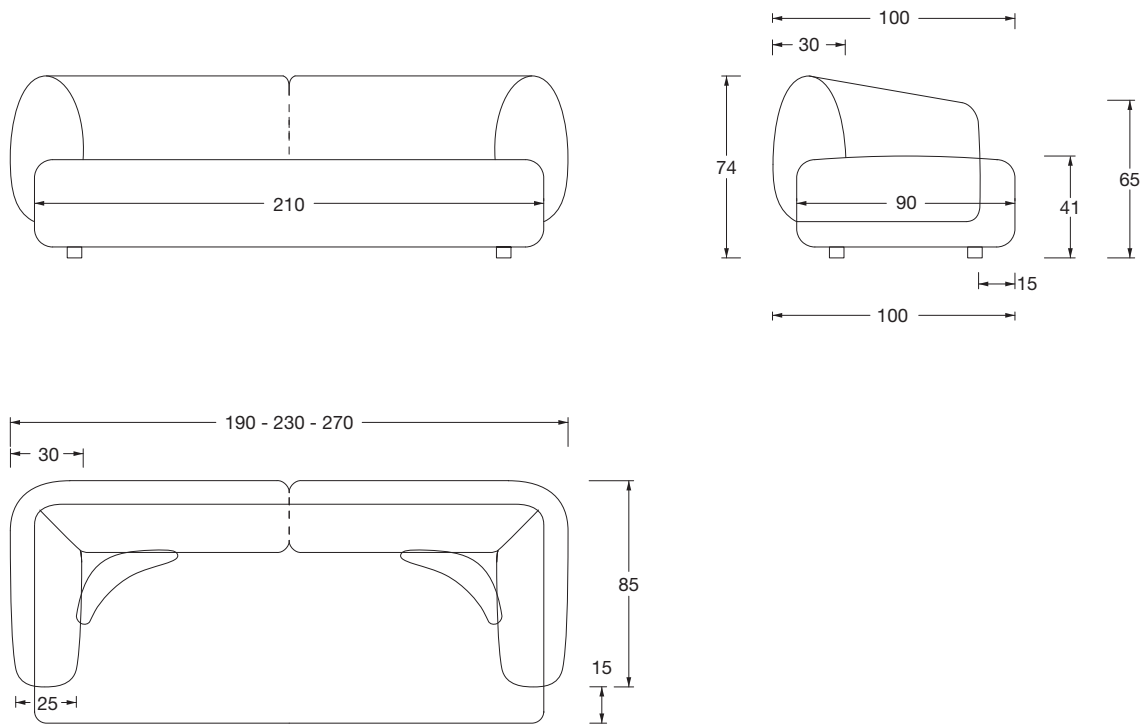



file 3D

Structure	<i>Estructura</i>	Structure
plywood and solid poplar and fir	<i>contrachapado y macizo de álamo y abeto</i>	contreplaqué en bois et bois massif de sapin et de peuplier
Base seat	<i>Base asiento</i>	Base assise
elastic belts 6/8 cm cross weft	<i>tirantes elásticos cruzados de 6/8 cm</i>	sangles élastiques 6 et 8 cm croisées
Seat	<i>Asiento</i>	Assise
polyurethane D35 IM MF D40	<i>poliuretano D35 IM MF D40</i>	polyuréthane D35 IM MF D40
Backrest	<i>Respaldo</i>	Dossier
polyurethane D35 IM MF D40	<i>poliuretano D35 IM MF D40</i>	polyuréthane D35 IM MF D40
Backrest cushion	<i>Cojín del respaldo</i>	Coussin de dossier
blend of goose feather and silicone fibre	<i>mezcla de pluma de ganso y fibra de silicon.</i>	mélange de duvet d'oie et de fibre de silicone
Feet	<i>Patas</i>	Pieds
wood	<i>madera</i>	bois

Completely removable cover

Con funda removable

Housse amovible

Sofas

Sofás
Canapés

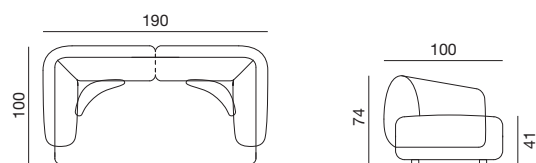

Description Descripción Description	Code Código Code	Side Lado Côté	Fabrics - <i>Telas</i> - Tissu				Leather - <i>Piel</i> - Cuir			C.O.M. fabric L./H. Tela cliente L./A. Tissu client L./H.	
			Cat. B	Cat. C/D	Cat. Must	Cat. K	Cat. E	Cat. Plus	Cat. Luxury		
Foam <i>Espuma</i> - Mousse	357CE1N 190		3.215	3.400	3.595	3.785	4.925	5.875	6.635	3.215	10,00/1,40
Cover <i>Revest.</i> - Housse	C57CE1N 190		880	1.080	1.280	1.480	2.680	3.680	4.485	880	10,00/1,40

m³ 1,60 - kg. 83

Sofas

Sofás
Canapés

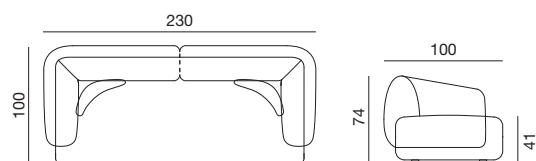

Description Descripción Description	Code Código Code	Side Lado Côté	Fabrics - <i>Telas</i> - Tissu				Leather - <i>Piel</i> - Cuir			C.O.M. fabric L./H. Tela cliente L./A. Tissu client L./H.	
			Cat. B	Cat. C/D	Cat. Must	Cat. K	Cat. E	Cat. Plus	Cat. Luxury		
Foam <i>Espuma</i> - Mousse	357CE1N 230		3.575	3.780	3.985	4.190	5.405	6.415	7.230	3.575	10,67/1,40
Cover <i>Revest.</i> - Housse	C57CE1N 230		920	1.135	1.345	1.560	2.840	3.905	4.760	920	10,67/1,40

m³ 1,93 - kg. 89

Sofas

Sofás
Canapés

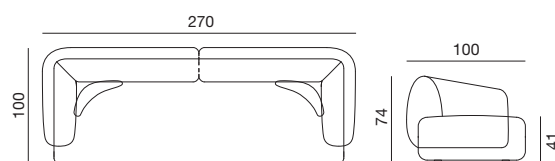

Description Descripción Description	Code Código Code	Side Lado Côté	Fabrics - <i>Telas</i> - Tissu				Leather - <i>Piel</i> - Cuir			C.O.M. fabric L./H. Tela cliente L./A. Tissu client L./H.	
			Cat. B	Cat. C/D	Cat. Must	Cat. K	Cat. E	Cat. Plus	Cat. Luxury		
Foam <i>Espuma</i> - Mousse	357CE1N 270		3.935	4.150	4.365	4.585	5.870	6.950	7.810	3.935	11,33/1,40
Cover <i>Revest.</i> - Housse	C57CE1N 270		960	1.185	1.410	1.640	3.000	4.135	5.040	960	11,33/1,40

m³ 2,27 - kg. 97

Side element

Lateral
Éléments latéraux

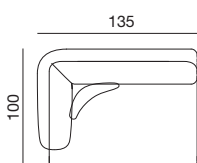

Description Descripción Description	Code Código Code	Side Lado Côté	Fabrics - <i>Telas</i> - Tissu				Leather - <i>Piel</i> - Cuir			C.O.M. fabric L./H. Tela cliente L./A. Tissu client L./H.	
			Cat. B	Cat. C/D	Cat. Must	Cat. K	Cat. E	Cat. Plus	Cat. Luxury		
Foam <i>Espuma</i> - Mousse	357CE2S 135 357CE2R 135	LH/IZDA/G. RH/DCHA/D.	2.320	2.435	2.550	2.660	3.340	3.905	4.360	2.320	5,66/1,40
Cover <i>Revest.</i> - Housse	C57CE2S 135 C57CE2R 135	LH/IZDA/G. RH/DCHA/D.	575	690	800	915	1.590	2.160	2.615	575	5,66/1,40

LH / IZDA / G.

m³ 1,13 - kg. 50

Side element

Lateral
Éléments latéraux

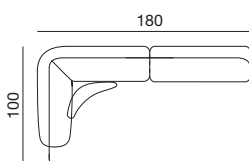

Description Descripción Description	Code Código Code	Side Lado Côté	Fabrics - <i>Telas</i> - Tissu				Leather - <i>Piel</i> - Cuir			C.O.M. fabric L./H. Tela cliente L./A. Tissu client L./H.	
			Cat. B	Cat. C/D	Cat. Must	Cat. K	Cat. E	Cat. Plus	Cat. Luxury		
Foam <i>Espuma</i> - Mousse	357CE2S 180 357CE2R 180	LH/IZDA/G. RH/DCHA/D.	3.105	3.270	3.435	3.600	4.580	5.400	6.060	3.105	8,25/1,40
Cover <i>Revest.</i> - Housse	C57CE2S 180 C57CE2R 180	LH/IZDA/G. RH/DCHA/D.	795	960	1.125	1.285	2.270	3.090	3.740	795	8,25/1,40

LH / IZDA / G.

m³ 1,51 - kg. 81

Side element

Lateral

Éléments latéraux

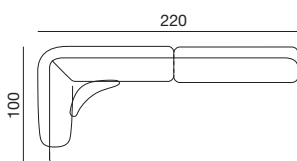

LH / IZDA / G.

Description Descripción Description	Code Código Code	Side Lado Côté	Fabrics - <i>Telas</i> - Tissu				Leather - <i>Piel</i> - Cuir			C.O.M. fabric L./H. <i>Tela cliente L./A.</i> Tissu client L./H.	
			Cat. B	Cat. C/D	Cat. Must	Cat. K	Cat. E	Cat. Plus	Cat. Luxury		
Foam <i>Espuma</i> - Mousse	357CE2S 220 357CE2R 220	LH / IZDA / G. RH / DCHA / D.	3.495	3.670	3.845	4.025	5.090	5.975	6.680	3.495	9,02/1,40
Cover <i>Revest.</i> - Housse	C57CE2S 220 C57CE2R 220	LH / IZDA / G. RH / DCHA / D.	835	1.010	1.190	1.365	2.430	3.315	4.025	835	9,02/1,40

m³ 1,85 - kg. 87

Side element

Lateral

Éléments latéraux

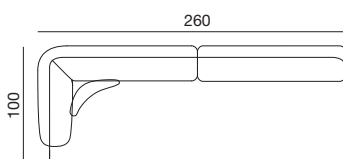

LH / IZDA / G.

Description Descripción Description	Code Código Code	Side Lado Côté	Fabrics - <i>Telas</i> - Tissu				Leather - <i>Piel</i> - Cuir			C.O.M. fabric L./H. <i>Tela cliente L./A.</i> Tissu client L./H.	
			Cat. B	Cat. C/D	Cat. Must	Cat. K	Cat. E	Cat. Plus	Cat. Luxury		
Foam <i>Espuma</i> - Mousse	357CE2S 260 357CE2R 260	LH / IZDA / G. RH / DCHA / D.	3.860	4.045	4.235	4.430	5.570	6.520	7.285	3.860	9,57/1,40
Cover <i>Revest.</i> - Housse	C57CE2S 260 C57CE2R 260	LH / IZDA / G. RH / DCHA / D.	870	1.065	1.255	1.445	2.585	3.540	4.300	870	9,57/1,40

m³ 2,18 - kg. 95

Central elements

Central

Chauffeuses

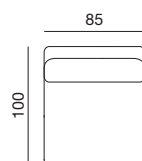

Description Descripción Description	Code Código Code	Side Lado Côté	Fabrics - <i>Telas</i> - Tissu				Leather - <i>Piel</i> - Cuir			C.O.M. fabric L./H. <i>Tela cliente L./A.</i> Tissu client L./H.	
			Cat. B	Cat. C/D	Cat. Must	Cat. K	Cat. E	Cat. Plus	Cat. Luxury		
Foam <i>Espuma</i> - Mousse	357CE3N 085		1.560	1.625	1.690	1.755	2.155	2.485	2.745	1.560	3,30/1,40
Cover <i>Revest.</i> - Housse	C57CE3N 085		425	490	560	625	1.020	1.350	1.615	425	3,30/1,40

m³ 0,71 - kg. 36

Central elements

Central

Chauffeuses

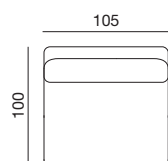

Description Descripción Description	Code Código Code	Side Lado Côté	Fabrics - <i>Telas</i> - Tissu				Leather - <i>Piel</i> - Cuir			C.O.M. fabric L./H. <i>Tela cliente L./A.</i> Tissu client L./H.	
			Cat. B	Cat. C/D	Cat. Must	Cat. K	Cat. E	Cat. Plus	Cat. Luxury		
Foam <i>Espuma</i> - Mousse	357CE3N 105		1.760	1.840	1.915	1.995	2.455	2.840	3.150	1.760	3,85/1,40
Cover <i>Revest.</i> - Housse	C57CE3N 105		465	540	620	695	1.155	1.540	1.850	465	3,85/1,40

m³ 0,88 - kg. 40

Central elements

Central

Chauffeuses

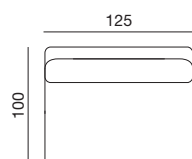

Description Descripción Description	Code Código Code	Side Lado Côté	Fabrics - <i>Telas</i> - Tissu				Leather - <i>Piel</i> - Cuir			C.O.M. fabric L./H. <i>Tela cliente L./A.</i> Tissu client L./H.	
			Cat. B	Cat. C/D	Cat. Must	Cat. K	Cat. E	Cat. Plus	Cat. Luxury		
Foam <i>Espuma</i> - Mousse	357CE3N 125		2.010	2.100	2.185	2.275	2.800	3.240	3.595	2.010	4,40/1,40
Cover <i>Revest.</i> - Housse	C57CE3N 125		495	585	675	760	1.290	1.730	2.080	495	4,40/1,40

m³ 1,05 - kg. 44

Corner

Ángulo
Élément d'angle

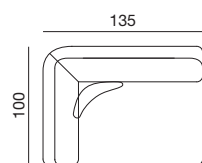

Description Descripción Description	Code Código Code	Side Lado Côté	Fabrics - <i>Telas</i> - Tissu				Leather - <i>Piel</i> - Cuir			C.O.M. fabric L./H. Tela cliente L./A. Tissu client L./H.	
			Cat. B	Cat. C/D	Cat. Must	Cat. K	Cat. E	Cat. Plus	Cat. Luxury		
Foam <i>Espuma</i> - Mousse	357CE4S 135 357CE4R 135	LH/IZDA/G. RH/DCHA/D.	2.465	2.585	2.715	2.840	3.585	4.205	4.705	2.465	6,21/1,40
Cover <i>Revest.</i> - Housse	C57CE4S 135 C57CE4R 135	LH/IZDA/G. RH/DCHA/D.	605	735	860	980	1.730	2.350	2.845	605	6,21/1,40

LH / IZDA / G.

m³ 1,57 - kg. 50

Chaise longues

Chaise longues - Chaise Longue

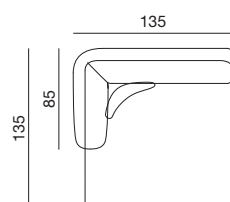

Description Descripción Description	Code Código Code	Side Lado Côté	Fabrics - <i>Telas</i> - Tissu				Leather - <i>Piel</i> - Cuir			C.O.M. fabric L./H. Tela cliente L./A. Tissu client L./H.	
			Cat. B	Cat. C/D	Cat. Must	Cat. K	Cat. E	Cat. Plus	Cat. Luxury		
Foam <i>Espuma</i> - Mousse	357CE5S 135 357CE5R 135	LH/IZDA/G. RH/DCHA/D.	2.740	2.895	3.045	3.190	4.100	4.855	5.455	2.740	7,53/1,40
Cover <i>Revest.</i> - Housse	C57CE5S 135 C57CE5R 135	LH/IZDA/G. RH/DCHA/D.	675	825	975	1.130	2.030	2.785	3.390	675	7,53/1,40

LH / IZDA / G.

m³ 1,57 - kg. 60

Chaise longues

Chaise longues - Chaise Longue

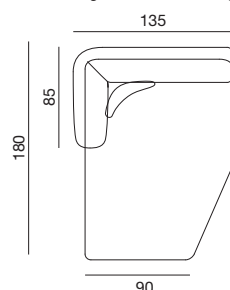

Description Descripción Description	Code Código Code	Side Lado Côté	Fabrics - <i>Telas</i> - Tissu				Leather - <i>Piel</i> - Cuir			C.O.M. fabric L./H. Tela cliente L./A. Tissu client L./H.	
			Cat. B	Cat. C/D	Cat. Must	Cat. K	Cat. E	Cat. Plus	Cat. Luxury		
Foam <i>Espuma</i> - Mousse	357CE5S 180 357CE5R 180	LH/IZDA/G. RH/DCHA/D.	3.045	3.190	3.345	3.495	4.400	5.155	5.755	3.045	7,53/1,40
Cover <i>Revest.</i> - Housse	C57CE5S 180 C57CE5R 180	LH/IZDA/G. RH/DCHA/D.	675	825	975	1.130	2.030	2.785	3.390	675	7,53/1,40

LH / IZDA / G.

m³ 1,86 - kg. 63

Footstool

Puff
Pouf

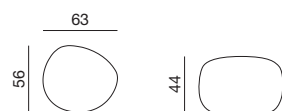

Description Descripción Description	Code Código Code	Side Lado Côté	Fabrics - <i>Telas</i> - Tissu				Leather - <i>Piel</i> - Cuir			C.O.M. fabric L./H. Tela cliente L./A. Tissu client L./H.	
			Cat. B	Cat. C/D	Cat. Must	Cat. K	Cat. E	Cat. Plus	Cat. Luxury		
Foam <i>Espuma</i> - Mousse	357CE8N 056		545	575	595	625	785	915	1.020	545	1,32/1,40
Cover <i>Revest.</i> - Housse	C57CE8N 056		135	160	190	215	375	510	615	135	1,32/1,40

m³ 0,16 - kg. 20

Footstool

Puff
Pouf

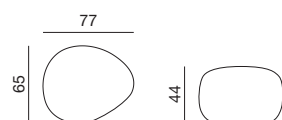

Description Descripción Description	Code Código Code	Side Lado Côté	Fabrics - <i>Telas</i> - Tissu				Leather - <i>Piel</i> - Cuir			C.O.M. fabric L./H. Tela cliente L./A. Tissu client L./H.	
			Cat. B	Cat. C/D	Cat. Must	Cat. K	Cat. E	Cat. Plus	Cat. Luxury		
Foam <i>Espuma</i> - Mousse	357CE8N 065		655	690	730	760	975	1.150	1.290	655	1,76/1,40
Cover <i>Revest.</i> - Housse	C57CE8N 065		165	200	240	270	485	660	800	165	1,76/1,40

m³ 0,22 - kg. 25

Footstool

Puff
Pouf

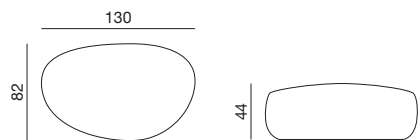

Description Descripción Description	Code Código Code	Side Lado Côté	Fabrics - <i>Telas</i> - Tissu				Leather - <i>Piel</i> - Cuir			C.O.M. fabric L./H. Tela cliente L./A. Tissu client L./H.
			Cat. B	Cat. C/D	Cat. Must	Cat. K	Cat. E	Cat. Plus	Cat. Luxury	
Foam <i>Espuma</i> - Mousse	357CE8N 082		1.000	1.045	1.095	1.145	1.440	1.680	1.870	1.000 2,42/1,40
Cover <i>Revest.</i> - Housse	C57CE8N 082		205	255	305	355	640	880	1.080	205 2,42/1,40

m³ 0,36 - kg. 30

Trapeze pouf

Puff trapecio
Pouf trapèze

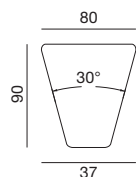

Description Descripción Description	Code Código Code	Side Lado Côté	Fabrics - <i>Telas</i> - Tissu				Leather - <i>Piel</i> - Cuir			C.O.M. fabric L./H. Tela cliente L./A. Tissu client L./H.
			Cat. B	Cat. C/D	Cat. Must	Cat. K	Cat. E	Cat. Plus	Cat. Luxury	
Foam <i>Espuma</i> - Mousse	357CE4N 090		870	915	960	1.005	1.265	1.485	1.665	870 2,20/1,40
Cover <i>Revest.</i> - Housse	C57CE4N 090		200	245	290	330	595	815	990	200 2,20/1,40

m³ 0,45 - kg. 25

Kamari cushions

Cojines Kamari - Coussins Kamari

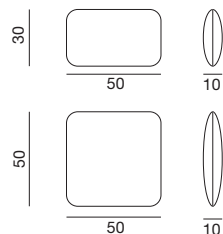

Description Descripción Description	Code Código Code	Side Lado Côté	Fabrics - <i>Telas</i> - Tissu				Leather - <i>Piel</i> - Cuir			C.O.M. fabric L./H. Tela cliente L./A. Tissu client L./H.
			Cat. B	Cat. C/D	Cat. Must	Cat. K	Cat. E	Cat. Plus	Cat. Luxury	
Feather <i>Pluma</i> - Plume	357EPCN 030	50x30	70	80	90	105	135	165	180	70 0,63/1,40
Feather <i>Pluma</i> - Plume	357EPCN 050	50x50	85	100	120	145	205	250	275	85 0,63/1,40

m³ 0,01 - kg. 0,6

m³ 0,02 - kg. 0,6

Kamari cushions

Cojines Kamari - Coussins Kamari

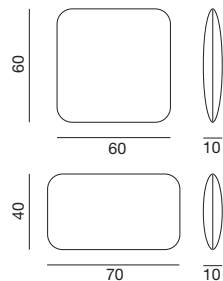

Description Descripción Description	Code Código Code	Side Lado Côté	Fabrics - <i>Telas</i> - Tissu				Leather - <i>Piel</i> - Cuir			C.O.M. fabric L./H. Tela cliente L./A. Tissu client L./H.
			Cat. B	Cat. C/D	Cat. Must	Cat. K	Cat. E	Cat. Plus	Cat. Luxury	
Feather <i>Pluma</i> - Plume	357EPCN 060	60x60	105	125	145	180	245	300	325	105 0,70/1,40
Feather <i>Pluma</i> - Plume	357EPCN 070	70x40	105	125	145	180	245	300	325	105 0,70/1,40

m³ 0,04 - kg. 0,6

m³ 0,04 - kg. 0,6

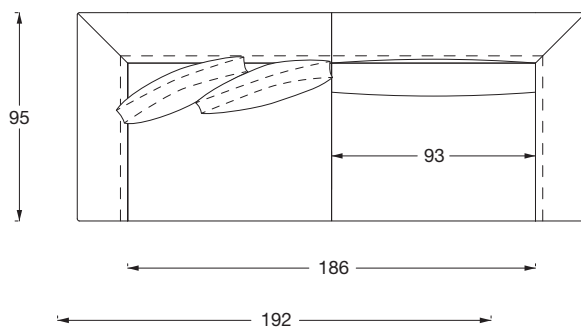
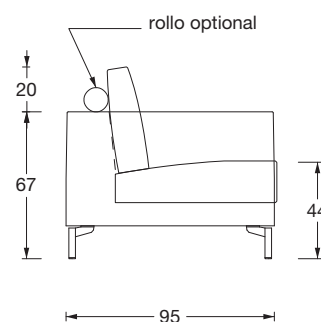
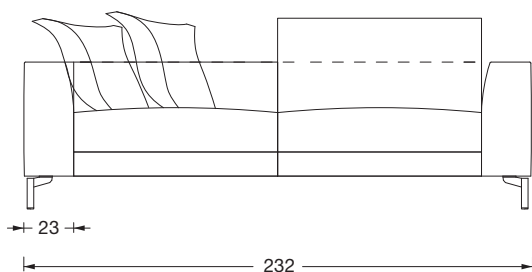

Base seat	plywood and solid poplar and fir elastic belts 6/8 cm cross weft pressed polyester fibre	<i>Base asiento</i>	<i>contrachapado y macizo de álamo y abeto tirantes elásticos cruzados de 6/8 cm fibra de poliéster prensada</i>	Base assise	contreplaqué en bois et bois massif de sapin et de peuplier sangles élastiques 6 et 8 cm croisées fibre de polyester pressée
Seat	goose feather blend polyurethane D35 IM polyurethane D25 FR	<i>Asiento</i>	<i>mezcla de pluma de ganso poliuretano D35 IM poliuretano D25 FR</i>	Assise	mélange de duvet d'oie polyurethane D35 IM polyurethane D25 FR
Backrest	wood fibre polyurethane D40 IM polyurethane D28	<i>Respaldo</i>	<i>fibra de madera poliuretano D40 IM Poliuretano D28</i>	Dossier	fibre de bois polyuréthane D40 IM polyuréthane D28
Backrest cushion	blend of goose feather and silicone fibre 100% cotton fabric	<i>Cojín del respaldo</i>	<i>mezcla de pluma de ganso y fibra de silicona tela 100% algodón</i>	Coussin de dossier	mélange de duvet d'oie et de fibre de silicone tissu 100% coton
Armrest	wood fibre polyurethane D40 IPP polyurethane D21 IM pressed polyester fibre	<i>Brazos</i>	<i>fibra de madera poliuretano D40 IPP poliuretano D21 IM fibra de poliéster prensada</i>	Accoudoir	fibre de bois polyurethane D40 IPP polyurethane D21 IM fibre de polyester pressée
Feet	metal feet painted black matt or Brown Bronze	<i>Patas</i>	<i>patas de metal pintado negro mate o Brown Bronze</i>	Pieds	Pieds en metal peint en noir mat ou Brown Bronze
Completely removable cover		<i>Con funda removible</i>		Housse amovible	

Sofas

Sofás
Canapés

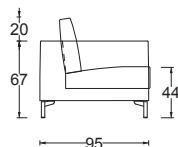
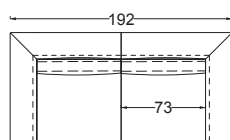

Description Descripción Description	Code Código Code	Side Lado Côté	Fabrics - <i>Telas</i> - Tissu				Leather - <i>Piel</i> - Cuir			C.O.M. fabric L./H. Tela cliente L./A. Tissu client L./H.	
			Cat. B	Cat. C/D	Cat. Must	Cat. K	Cat. E	Cat. Plus	Cat. Luxury		
Composition Composición Composition	35FCP1N 192 + 2x 35FEPCN 073		2.940	3.090	3.260	3.430	4.395	5.220	5.875	2.940	10,72/1,40

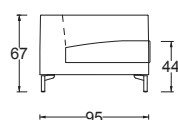
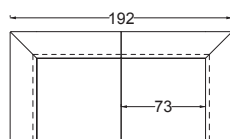

Feather Pluma - Plume	35FCP1N 192		2.570	2.690	2.820	2.940	3.675	4.290	4.785	2.570	8,80/1,40
Cover Revest. - Housse	C5FCE1N 192		690	825	975	1.125	-	-	-	690	8,80/1,40

m³ 1,70 - kg. 73

Sofas

Sofás
Canapés

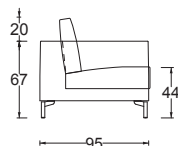
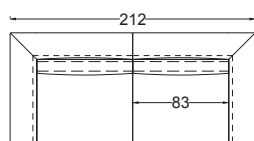

Description Descripción Description	Code Código Code	Side Lado Côté	Fabrics - <i>Telas</i> - Tissu				Leather - <i>Piel</i> - Cuir			C.O.M. fabric L./H. Tela cliente L./A. Tissu client L./H.	
			Cat. B	Cat. C/D	Cat. Must	Cat. K	Cat. E	Cat. Plus	Cat. Luxury		
Composition Composición Composition	35FCP1N 212 + 2x 35FEPCN 083		3.050	3.215	3.405	3.580	4.610	5.465	6.150	3.050	11,47/1,40

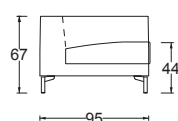
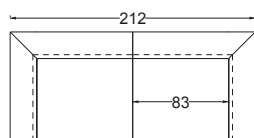

Feather Pluma - Plume	35FCP1N 212		2.670	2.795	2.925	3.050	3.820	4.455	4.970	2.670	9,35/1,40
Cover Revest. - Housse	C5FCE1N 212		715	860	1015	1170	-	-	-	715	9,35/1,40

m³ 1,85 - kg. 78

Sofas

Sofás
Canapés

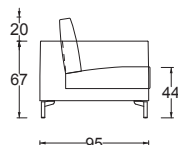
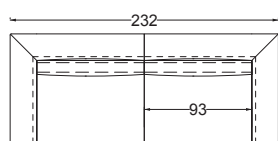

Description Descripción Description	Code Código Code	Side Lado Côté	Fabrics - <i>Telas</i> - Tissu				Leather - <i>Piel</i> - Cuir			C.O.M. fabric L./H. Tela cliente L./A. Tissu client L./H.	
			Cat. B	Cat. C/D	Cat. Must	Cat. K	Cat. E	Cat. Plus	Cat. Luxury		
Composition Composición Composition	35FCP1N 232 + 2x 35FEPCN 093		3.145	3.320	3.510	3.695	4.760	5.655	6.375	3.145	12,22/1,40

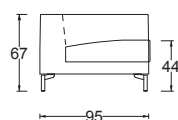
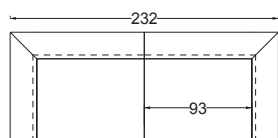

Feather Pluma - Plume	35FCP1N 232		2.745	2.880	3.010	3.145	3.940	4.605	5.135	2.745	9,90/1,40
Cover Revest. - Housse	C5FCE1N 232		735	890	1040	1200	-	-	-	735	9,90/1,40

m³ 2,00 - kg. 84

Sofas

Sofás
Canapés

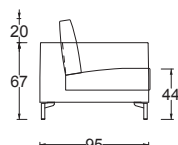
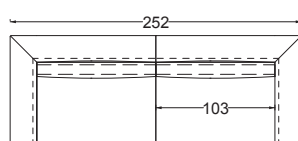

Description Descripción Description	Code Código Code	Side Lado Côté	Fabrics - <i>Telas</i> - Tissu				Leather - <i>Piel</i> - Cuir			C.O.M. fabric L./H. Tela cliente L./A. Tissu client L./H.	
			Cat. B	Cat. C/D	Cat. Must	Cat. K	Cat. E	Cat. Plus	Cat. Luxury		
Composition Composición Composition	35FCP1N 252 + 2x 35FEPCN 103		3.245	3.425	3.615	3.810	4.900	5.820	6.560	3.245	12,97/1,40

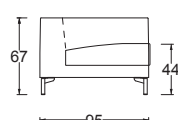
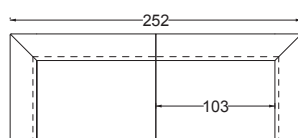

Feather Pluma - Plume	35FCP1N 252		2.825	2.955	3.095	3.230	4.050	4.730	5.280	2.825	10,45/1,40
Cover Revest. - Housse	C5FCE1N 252		755	910	1070	1235	-	-	-	755	10,45/1,40

m³ 2,20 - kg. 90

Side element

Lateral - Éléments latéraux

LH / IZDA / G.

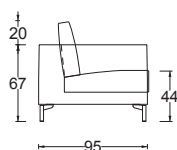
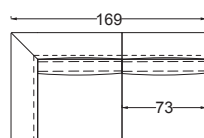

Description Descripción Description	Code Código Code	Side Lado Côté	Fabrics - <i>Telas</i> - Tissu				Leather - <i>Piel</i> - Cuir			C.O.M. fabric L./H. Tela cliente L./A. Tissu client L./H.	
			Cat. B	Cat. C/D	Cat. Must	Cat. K	Cat. E	Cat. Plus	Cat. Luxury		
Composition Composición Composition	35FCP2S/R 169 + 2x 35FEPCN 073	LH / IZDA / G. RH / DCHA / D.	2.655	2.790	2.930	3.090	3.945	4.670	5.255	2.655	9,94/1,40

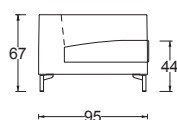
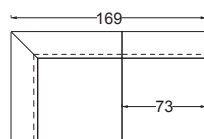

Feather <i>Pluma</i> - Plume	35FCP2S 169 35FCP2R 169	LH / IZDA / G. RH / DCHA / D.	2.285	2.390	2.490	2.600	3.225	3.740	4.165	2.285	8,25/1,40
Cover <i>Revest.</i> - Housse	C5FCE2S 169 C5FCE2R 169	LH / IZDA / G. RH / DCHA / D.	615	735	860	990	-	-	-	615	8,25/1,40

m³ 1,10 - kg. 45

Side element

Lateral - Éléments latéraux

LH / IZDA / G.

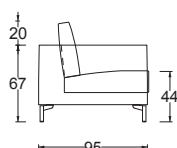
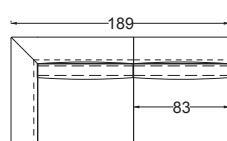

Description Descripción Description	Code Código Code	Side Lado Côté	Fabrics - <i>Telas</i> - Tissu				Leather - <i>Piel</i> - Cuir			C.O.M. fabric L./H. Tela cliente L./A. Tissu client L./H.	
			Cat. B	Cat. C/D	Cat. Must	Cat. K	Cat. E	Cat. Plus	Cat. Luxury		
Composition Composición Composition	35FCP2S/R 189 + 2x 35FEPCN 083	LH / IZDA / G. RH / DCHA / D.	2.745	2.895	3.060	3.220	4.135	4.900	5.505	2.745	10,69/1,40

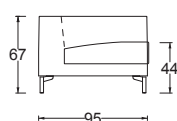
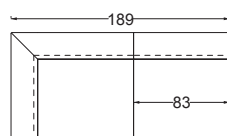

Feather <i>Pluma</i> - Plume	35FCP2S 189 35FCP2R 189	LH / IZDA / G. RH / DCHA / D.	2.365	2.475	2.580	2.690	3.345	3.890	4.325	2.365	8,80/1,40
Cover <i>Revest.</i> - Housse	C5FCE2S 189 C5FCE2R 189	LH / IZDA / G. RH / DCHA / D.	635	760	895	1030	-	-	-	635	8,80/1,40

m³ 1,60 - kg. 60

Side element

Lateral - Éléments latéraux

LH / IZDA / G.

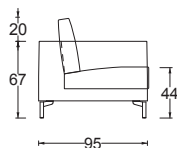
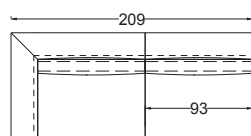

Description Descripción Description	Code Código Code	Side Lado Côté	Fabrics - <i>Telas</i> - Tissu				Leather - <i>Piel</i> - Cuir			C.O.M. fabric L./H. Tela cliente L./A. Tissu client L./H.	
			Cat. B	Cat. C/D	Cat. Must	Cat. K	Cat. E	Cat. Plus	Cat. Luxury		
Composition Composición Composition	35FCP2S/R 209 + 2x 35FEPCN 093	LH / IZDA / G. RH / DCHA / D.	2.850	3.005	3.175	3.340	4.280	5.075	5.710	2.850	11,44/1,40

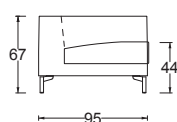
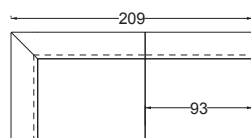

Feather <i>Pluma</i> - Plume	35FCP2S 209 35FCP2R 209	LH / IZDA / G. RH / DCHA / D.	2.450	2.565	2.675	2.790	3.460	4.025	4.470	2.450	9,35/1,40
Cover <i>Revest.</i> - Housse	C5FCE2S 209 C5FCE2R 209	LH / IZDA / G. RH / DCHA / D.	655	790	925	1070	-	-	-	655	9,35/1,40

m³ 1,70 - kg. 65

Side element

Lateral - Éléments latéraux

LH / IZDA / G.

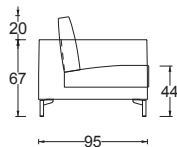
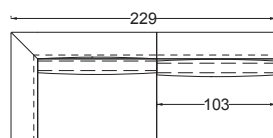

Description Descripción Description	Code Código Code	Side Lado Côté	Fabrics - <i>Telas</i> - Tissu				Leather - <i>Piel</i> - Cuir			C.O.M. fabric L./H. Tela cliente L./A. Tissu client L./H.	
			Cat. B	Cat. C/D	Cat. Must	Cat. K	Cat. E	Cat. Plus	Cat. Luxury		
Composition Composición Composition	35FCP2S/R 229 + 2x 35FEPCN 103	LH / IZDA / G. RH / DCHA / D.	2.945	3.110	3.280	3.455	4.420	5.240	5.890	2.945	12,19/1,40

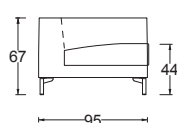
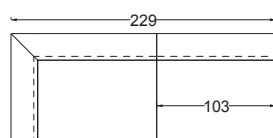

Feather <i>Pluma</i> - Plume	35FCP2S 229 35FCP2R 229	LH / IZDA / G. RH / DCHA / D.	2.525	2.640	2.760	2.875	3.570	4.150	4.610	2.525	9,90/1,40
Cover <i>Revest.</i> - Housse	C5FCE2S 229 C5FCE2R 229	LH / IZDA / G. RH / DCHA / D.	680	815	955	1095	-	-	-	680	9,90/1,40

m³ 1,80 - kg. 70

Central elements

Central

Chauffeuses

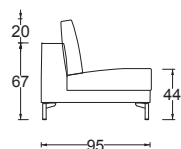
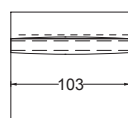

Description Descripción Description	Code Código Code	Side Lado Côté	Fabrics - <i>Telas</i> - Tissu				Leather - <i>Piel</i> - Cuir			C.O.M. fabric L./H. Tela cliente L./A. Tissu client L./H.	
			Cat. B	Cat. C/D	Cat. Must	Cat. K	Cat. E	Cat. Plus	Cat. Luxury		
Composition Composición Composition	35FCP3N 103 + 35FEPCN 103		2.040	2.150	2.265	2.390	3.060	3.635	4.090	2.040	5,98/1,40

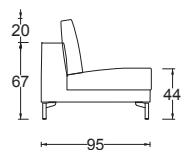
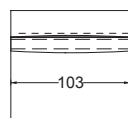

Feather Pluma - Plume	35FCP3N 103		1.830	1.915	2.005	2.100	2.635	3.090	3.450	1.830	4,95/1,40
Cover Revest. - Housse	C5FCE3N 103		490	590	695	805	-	-	-	490	4,95/1,40

m³ 2,00 - kg. 84

Central elements

Central

Chauffeuses

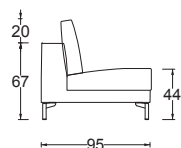
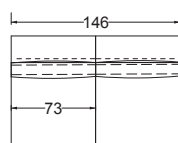

Description Descripción Description	Code Código Code	Side Lado Côté	Fabrics - <i>Telas</i> - Tissu				Leather - <i>Piel</i> - Cuir			C.O.M. fabric L./H. Tela cliente L./A. Tissu client L./H.	
			Cat. B	Cat. C/D	Cat. Must	Cat. K	Cat. E	Cat. Plus	Cat. Luxury		
Composition Composición Composition	35FCP3N 146 + 2x 35FEPCN 073		2.540	2.690	2.855	3.030	3.995	4.820	5.475	2.540	9,16/1,40

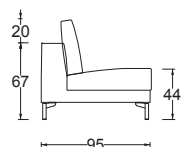
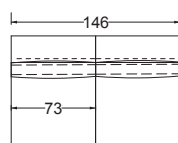

Feather Pluma - Plume	35FCP3N 146		2.170	2.290	2.415	2.540	3.275	3.890	4.385	2.170	7,70/1,40
Cover Revest. - Housse	C5FCE3N 146		580	705	840	970	-	-	-	580	7,70/1,40

m³ 1,90 - kg. 75

Central elements

Central

Chauffeuses

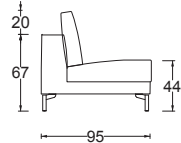
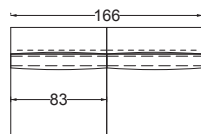

Description Descripción Description	Code Código Code	Side Lado Côté	Fabrics - <i>Telas</i> - Tissu				Leather - <i>Piel</i> - Cuir			C.O.M. fabric L./H. Tela cliente L./A. Tissu client L./H.	
			Cat. B	Cat. C/D	Cat. Must	Cat. K	Cat. E	Cat. Plus	Cat. Luxury		
Composition Composición Composition	35FCP3N 166 + 2x 35FEPCN 083		2.650	2.815	3.000	3.180	4.210	5.065	5.745	2.650	9,91/1,40

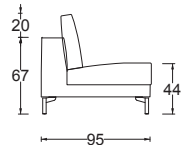
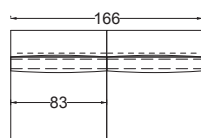

Feather Pluma - Plume	35FCP3N 166		2.270	2.395	2.520	2.650	3.420	4.055	4.565	2.270	8,25/1,40
Cover Revest. - Housse	C5FCE3N 166		605	740	870	1.015	-	-	-	605	8,25/1,40

m³ 1,70 - kg. 60

Central elements

Central

Chauffeuses

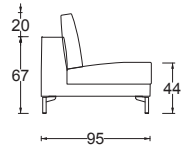
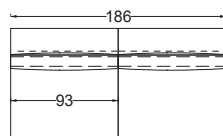

Description Descripción Description	Code Código Code	Side Lado Côté	Fabrics - <i>Telas</i> - Tissu				Leather - <i>Piel</i> - Cuir			C.O.M. fabric L./H. Tela cliente L./A. Tissu client L./H.	
			Cat. B	Cat. C/D	Cat. Must	Cat. K	Cat. E	Cat. Plus	Cat. Luxury		
Composition Composición Composition	35FCP3N 186 + 2x 35FEPCN 093		2.745	2.915	3.110	3.290	4.360	5.255	5.970	2.745	1,066/1,40

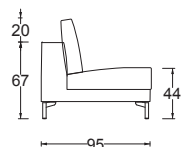
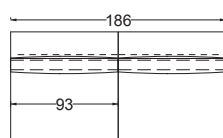

Feather Pluma - Plume	35FCP3N 186		2.345	2.475	2.610	2.740	3.540	4.205	4.730	2.345	8,80/1,40
Cover Revest. - Housse	C5FCE3N 186		630	760	905	1.045	-	-	-	630	8,80/1,40

m³ 1,70 - kg. 73

Central elements

Central

Chauffeuses

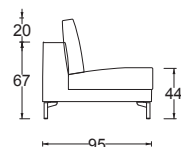
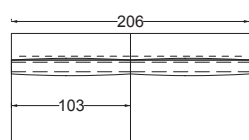

Description Descripción Description	Code Código Code	Side Lado Côté	Fabrics - <i>Telas</i> - Tissu				Leather - <i>Piel</i> - Cuir			C.O.M. fabric L./H. Tela cliente L./A. Tissu client L./H.	
			Cat. B	Cat. C/D	Cat. Must	Cat. K	Cat. E	Cat. Plus	Cat. Luxury		
Composition Composición Composition	35FCP3N 206 + 2x 35FEPCN 103		2.840	3.025	3.210	3.410	4.500	5.420	6.160	2.840	11,41/1,40

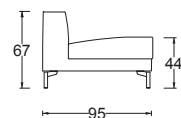
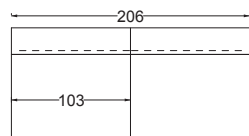

Feather <i>Pluma</i> - Plume	35FCP3N 206		2.420	2.555	2.690	2.830	3.650	4.330	4.880	2.420	9,35/1,40
Cover <i>Revest.</i> - Housse	C5FCE3N 206		650	790	930	1.080	-	-	-	650	9,35/1,40

m³ 1,85 - kg. 78

Chaise longues

Chaise longues - Chaise Longue

LH / IZDA / G.

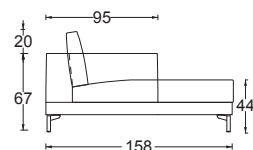
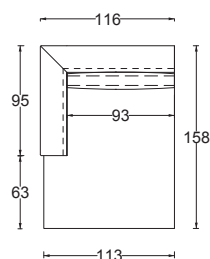

Description Descripción Description	Code Código Code	Side Lado Côté	Fabrics - <i>Telas</i> - Tissu				Leather - <i>Piel</i> - Cuir			C.O.M. fabric L./H. Tela cliente L./A. Tissu client L./H.	
			Cat. B	Cat. C/D	Cat. Must	Cat. K	Cat. E	Cat. Plus	Cat. Luxury		
Composition Composición Composition	35FCP5S/R 116 + 35FEPCN 093	LH / IZDA / G. RH / DCHA / D.	2.385	2.520	2.665	2.815	3.640	4.340	4.900	2.385	7,76/1,40

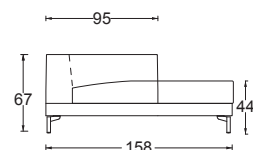
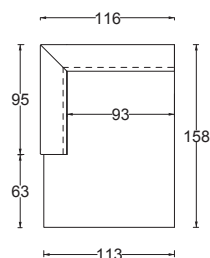

Description Descripción Description	Code Código Code	Side Lado Côté	Fabrics - <i>Telas</i> - Tissu				Leather - <i>Piel</i> - Cuir			C.O.M. fabric L./H. Tela cliente L./A. Tissu client L./H.	
			Cat. B	Cat. C/D	Cat. Must	Cat. K	Cat. E	Cat. Plus	Cat. Luxury		
Feather <i>Pluma</i> - Plume	35FCP5S 116 35FCP5R 116	LH / IZDA / G. RH / DCHA / D.	2.185	2.300	2.415	2.540	3.230	3.815	4.280	2.185	6,60/1,40
Cover <i>Revest.</i> - Housse	C5FCE5S 116 C5FCE5R 116	LH / IZDA / G. RH / DCHA / D.	585	710	840	970	-	-	-	585	6,60/1,40

m³ 2,20 - kg. 90

Dormeuse

Meridienne - Méridienne

LH / IZDA / G.

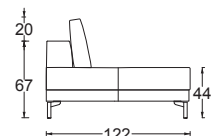
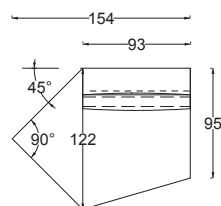

Description Descripción Description	Code Código Code	Side Lado Côté	Fabrics - <i>Telas</i> - Tissu				Leather - <i>Piel</i> - Cuir			C.O.M. fabric L./H. Tela cliente L./A. Tissu client L./H.	
			Cat. B	Cat. C/D	Cat. Must	Cat. K	Cat. E	Cat. Plus	Cat. Luxury		
Composition Composición Composition	35FCP7S/R 154 + 35FEPCN 093	LH / IZDA / G. RH / DCHA / D.	2.220	2.335	2.465	2.585	3.310	3.915	4.400	2.220	7,04/1,40

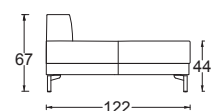
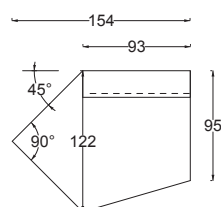

Description Descripción Description	Code Código Code	Side Lado Côté	Fabrics - <i>Telas</i> - Tissu				Leather - <i>Piel</i> - Cuir			C.O.M. fabric L./H. Tela cliente L./A. Tissu client L./H.	
			Cat. B	Cat. C/D	Cat. Must	Cat. K	Cat. E	Cat. Plus	Cat. Luxury		
Feather <i>Pluma</i> - Plume	35FCP7S 154 35FCP7R 154	LH / IZDA / G. RH / DCHA / D.	2.020	2.115	2.215	2.310	2.900	3.390	3.780	2.020	5,50/1,40
Cover <i>Revest.</i> - Housse	C5FCE7S 154 C5FCE7R 154	LH / IZDA / G. RH / DCHA / D.	540	650	765	890	-	-	-	540	5,50/1,40

m³ 1,10 - kg. 45

Sofas

Sofás
Canapés

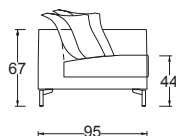
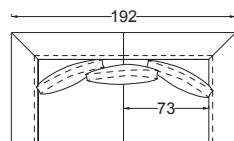

Description Descripción Description	Code Código Code	Side Lado Côté	Fabrics - <i>Telas</i> - Tissu				Leather - <i>Piel</i> - Cuir			C.O.M. fabric L./H. Tela cliente L./A. Tissu client L./H.	
			Cat. B	Cat. C/D	Cat. Must	Cat. K	Cat. E	Cat. Plus	Cat. Luxury		
Composition Composición Composition	35FCP1N 192 + 3x 35FEPBN 58x55		3.050	3.230	3.420	3.600	4.650	5.550	6.255	3.050	10,72/1,40

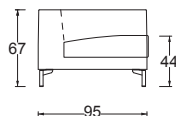
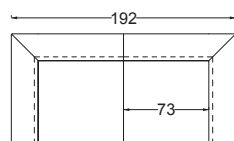

Feather <i>Pluma</i> - Plume	35FCP1N 192		2.570	2.690	2.820	2.940	3.675	4.290	4.785	2.570	8,80/1,40
Cover <i>Revest.</i> - Housse	35FCE1N 192		690	825	975	1.125	-	-	-	690	8,80/1,40

m³ 1,70 - kg. 73

Sofas

Sofás
Canapés

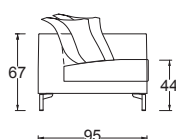
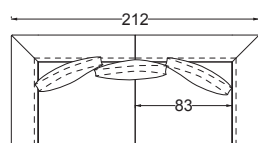

Description Descripción Description	Code Código Code	Side Lado Côté	Fabrics - <i>Telas</i> - Tissu				Leather - <i>Piel</i> - Cuir			C.O.M. fabric L./H. Tela cliente L./A. Tissu client L./H.	
			Cat. B	Cat. C/D	Cat. Must	Cat. K	Cat. E	Cat. Plus	Cat. Luxury		
Composition Composición Composition	35FCP1N 212 + 3x 35FEPBN 58x55		3.150	3.335	3.525	3.710	4.795	5.715	6.440	3.150	11,47/1,40

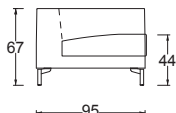
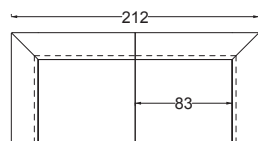

Feather <i>Pluma</i> - Plume	35FCP1N 212		2.670	2.795	2.925	3.050	3.820	4.455	4.970	2.670	9,35/1,40
Cover <i>Revest.</i> - Housse	35FCE1N 212		715	860	1015	1170	-	-	-	715	9,35/1,40

m³ 1,85 - kg. 78

Sofas

Sofás
Canapés

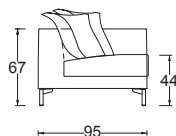
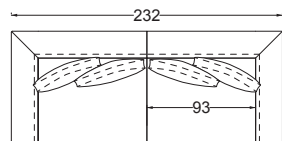

Description Descripción Description	Code Código Code	Side Lado Côté	Fabrics - <i>Telas</i> - Tissu				Leather - <i>Piel</i> - Cuir			C.O.M. fabric L./H. Tela cliente L./A. Tissu client L./H.	
			Cat. B	Cat. C/D	Cat. Must	Cat. K	Cat. E	Cat. Plus	Cat. Luxury		
Composition Composición Composition	35FCP1N 232 + 4x 35FEPBN 58x55		3.385	3.600	3.810	4.025	5.240	6.285	7.095	3.385	12,22/1,40

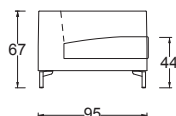
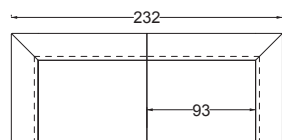

Feather <i>Pluma</i> - Plume	35FCP1N 232		2.745	2.880	3.010	3.145	3.940	4.605	5.135	2.745	9,90/1,40
Cover <i>Revest.</i> - Housse	35FCE1N 232		735	890	1040	1200	-	-	-	735	9,90/1,40

m³ 2,00 - kg. 84

Sofas

Sofás
Canapés

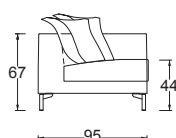
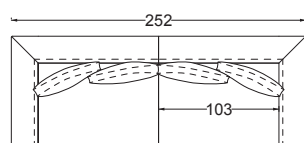

Description Descripción Description	Code Código Code	Side Lado Côté	Fabrics - <i>Telas</i> - Tissu				Leather - <i>Piel</i> - Cuir			C.O.M. fabric L./H. Tela cliente L./A. Tissu client L./H.	
			Cat. B	Cat. C/D	Cat. Must	Cat. K	Cat. E	Cat. Plus	Cat. Luxury		
Composition Composición Composition	35FCP1N 252 + 4x 35FEPBN 58x55		3.465	3.675	3.895	4.110	5.350	6.410	7.240	3.465	12,97/1,40

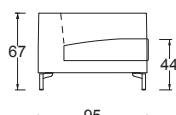
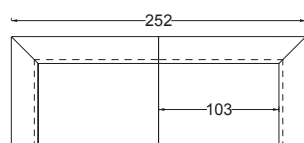

Feather <i>Pluma</i> - Plume	35FCP1N 252		2.825	2.955	3.095	3.230	4.050	4.730	5.280	2.825	10,45/1,40
Cover <i>Revest.</i> - Housse	35FCE1N 252		755	910	1070	1235	-	-	-	755	10,45/1,40

m³ 2,20 - kg. 90

Side element

Lateral - Éléments latéraux

LH / IZDA / G.

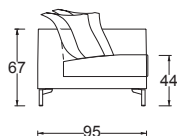
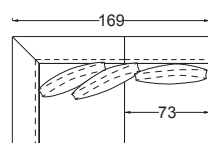

Description Descripción Description	Code Código Code	Side Lado Côté	Fabrics - <i>Telas</i> - Tissu				Leather - <i>Piel</i> - Cuir			C.O.M. fabric L./H. Tela cliente L./A. Tissu client L./H.	
			Cat. B	Cat. C/D	Cat. Must	Cat. K	Cat. E	Cat. Plus	Cat. Luxury		
Composition Composición Composition	35FCP2S/R 169 + 3x 35FEPBN 58x55	LH / IZDA / G. RH / DCHA / D.	2.765	2.930	3.090	3.260	4.200	5.000	5.635	2.765	9,94/1,40

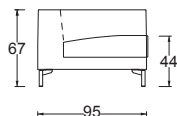
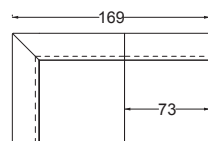

Feather <i>Pluma</i> - Plume	35FCP2S 169 35FCP2R 169	LH / IZDA / G. RH / DCHA / D.	2.285	2.390	2.490	2.600	3.225	3.740	4.165	2.285	8,25/1,40
Cover <i>Revest.</i> - Housse	C5FCE2S 169 C5FCE2R 169	LH / IZDA / G. RH / DCHA / D.	615	735	860	990	-	-	-	615	8,25/1,40

m³ 1,10 - kg. 45

Side element

Lateral - Éléments latéraux

LH / IZDA / G.

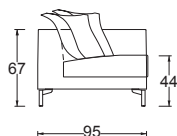
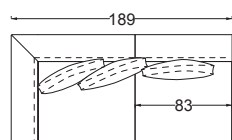

Description Descripción Description	Code Código Code	Side Lado Côté	Fabrics - <i>Telas</i> - Tissu				Leather - <i>Piel</i> - Cuir			C.O.M. fabric L./H. Tela cliente L./A. Tissu client L./H.	
			Cat. B	Cat. C/D	Cat. Must	Cat. K	Cat. E	Cat. Plus	Cat. Luxury		
Composition Composición Composition	35FCP2S/R 189 + 3x 35FEPBN 58x55	LH / IZDA / G. RH / DCHA / D.	2.845	3.015	3.180	3.350	4.320	5.150	5.795	2.845	10,69/1,40

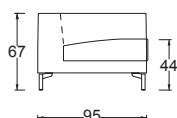
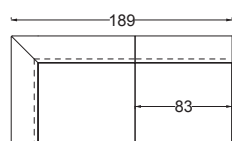

Feather <i>Pluma</i> - Plume	35FCP2S 189 35FCP2R 189	LH / IZDA / G. RH / DCHA / D.	2.365	2.475	2.580	2.690	3.345	3.890	4.325	2.365	8,80/1,40
Cover <i>Revest.</i> - Housse	C5FCE2S 189 C5FCE2R 189	LH / IZDA / G. RH / DCHA / D.	635	760	895	1030	-	-	-	635	8,80/1,40

m³ 1,60 - kg. 60

Side element

Lateral - Éléments latéraux

LH / IZDA / G.

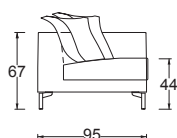
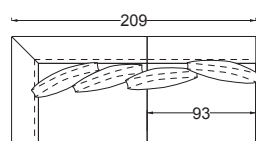

Description Descripción Description	Code Código Code	Side Lado Côté	Fabrics - <i>Telas</i> - Tissu				Leather - <i>Piel</i> - Cuir			C.O.M. fabric L./H. Tela cliente L./A. Tissu client L./H.	
			Cat. B	Cat. C/D	Cat. Must	Cat. K	Cat. E	Cat. Plus	Cat. Luxury		
Composition Composición Composition	35FCP2S/R 209 + 4x 35FEPBN 58x55	LH / IZDA / G. RH / DCHA / D.	3.090	3.285	3.475	3.670	4.760	5.705	6.430	3.090	11,40/1,40

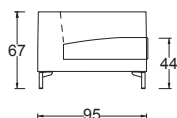
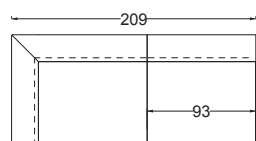

Feather <i>Pluma</i> - Plume	35FCP2S 209 35FCP2R 209	LH / IZDA / G. RH / DCHA / D.	2.450	2.565	2.675	2.790	3.460	4.025	4.470	2.450	9,35/1,40
Cover <i>Revest.</i> - Housse	C5FCE2S 209 C5FCE2R 209	LH / IZDA / G. RH / DCHA / D.	655	790	925	1070	-	-	-	655	9,35/1,40

m³ 1,70 - kg. 65

Side element

Lateral - Éléments latéraux

LH / IZDA / G.

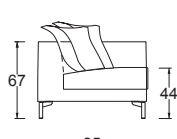
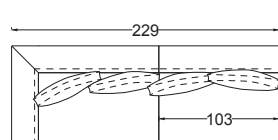

Description Descripción Description	Code Código Code	Side Lado Côté	Fabrics - <i>Telas</i> - Tissu				Leather - <i>Piel</i> - Cuir			C.O.M. fabric L./H. Tela cliente L./A. Tissu client L./H.	
			Cat. B	Cat. C/D	Cat. Must	Cat. K	Cat. E	Cat. Plus	Cat. Luxury		
Composition Composición Composition	35FCP2S/R 229 + 4x 35FEPBN 58x55	LH / IZDA / G. RH / DCHA / D.	3.165	3.360	3.560	3.755	4.870	5.830	6.570	3.165	12,19/1,40

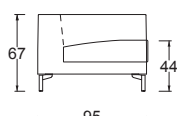
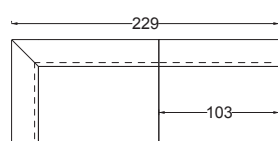

Feather <i>Pluma</i> - Plume	35FCP2S 229 35FCP2R 229	LH / IZDA / G. RH / DCHA / D.	2.525	2.640	2.760	2.875	3.570	4.150	4.610	2.525	9,90/1,40
Cover <i>Revest.</i> - Housse	C5FCE2S 229 C5FCE2R 229	LH / IZDA / G. RH / DCHA / D.	680	815	955	1095	-	-	-	680	9,90/1,40

m³ 1,80 - kg. 70

Central elements

Central

Chauffeuses

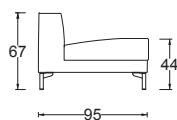
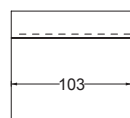
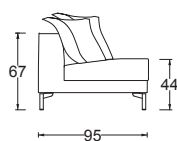
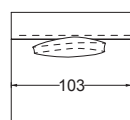

Description Descripción Description	Code Código Code	Side Lado Côté	Fabrics - Telas - Tissu				Leather - Piel - Cuir			C.O.M. fabric L./H. Tela cliente L./A. Tissu client L./H.	
			Cat. B	Cat. C/D	Cat. Must	Cat. K	Cat. E	Cat. Plus	Cat. Luxury		
Composition Composición Composition	35FCP3N 103 + 35FEPBN 58x55		1.990	2.095	2.205	2.320	2.960	3.510	3.940	1.990	5,98/1,40
Feather Pluma - Plume	35FCP3N 103		1.830	1.915	2.005	2.100	2.635	3.090	3.450	1.830	4,95/1,40
Cover Revest. - Housse	C60CE3N 103		490	590	695	805	-	-	-	490	4,95/1,40

m³ 2,00 - kg. 84

Central elements

Central

Chauffeuses

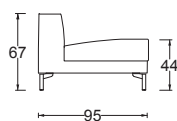
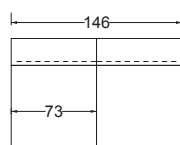
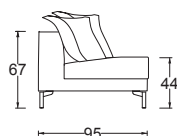
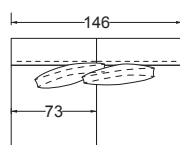

Description Descripción Description	Code Código Code	Side Lado Côté	Fabrics - Telas - Tissu				Leather - Piel - Cuir			C.O.M. fabric L./H. Tela cliente L./A. Tissu client L./H.	
			Cat. B	Cat. C/D	Cat. Must	Cat. K	Cat. E	Cat. Plus	Cat. Luxury		
Composition Composición Composition	35FCP3N 146 + 2x 35FEPBN 58x55		2.490	2.650	2.815	2.980	3.925	4.730	5.365	2.490	9,16/1,40
Feather Pluma - Plume	35FCP3N 146		2.170	2.290	2.415	2.540	3.275	3.890	4.385	2.170	7,70/1,40
Cover Revest. - Housse	C60CE3N 146		580	705	840	970	-	-	-	580	7,70/1,40

m³ 1,90 - kg. 75

Central elements

Central

Chauffeuses

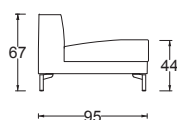
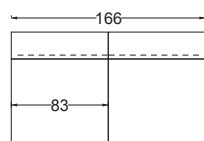
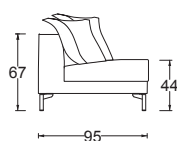
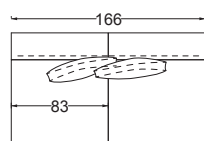

Description Descripción Description	Code Código Code	Side Lado Côté	Fabrics - Telas - Tissu				Leather - Piel - Cuir			C.O.M. fabric L./H. Tela cliente L./A. Tissu client L./H.	
			Cat. B	Cat. C/D	Cat. Must	Cat. K	Cat. E	Cat. Plus	Cat. Luxury		
Composition Composición Composition	35FCP3N 166 + 2x 35FEPBN 58x55		2.590	2.755	2.920	3.090	4.070	4.895	5.545	2.590	9,91/1,40
Feather Pluma - Plume	35FCP3N 166		2.270	2.395	2.520	2.650	3.420	4.055	4.565	2.270	8,25/1,40
Cover Revest. - Housse	C60CE3N 166		605	740	870	1.015	-	-	-	605	8,25/1,40

m³ 1,70 - kg. 60

Central elements

Central

Chauffeuses

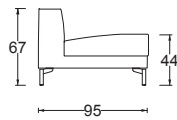
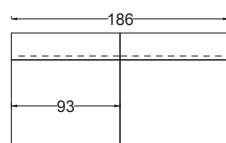
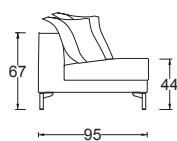
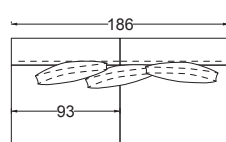

Description Descripción Description	Code Código Code	Side Lado Côté	Fabrics - Telas - Tissu				Leather - Piel - Cuir			C.O.M. fabric L./H. Tela cliente L./A. Tissu client L./H.	
			Cat. B	Cat. C/D	Cat. Must	Cat. K	Cat. E	Cat. Plus	Cat. Luxury		
Composition Composición Composition	35FCP3N 186 + 3x 35FEPBN 58x55		2.825	3.015	3.210	3.400	4.515	5.465	6.200	2.825	10,66/1,40
Feather Pluma - Plume	35FCP3N 186		2.345	2.475	2.610	2.740	3.540	4.205	4.730	2.345	8,80/1,40
Cover Revest. - Housse	C60CE3N 186		630	760	905	1.045	-	-	-	630	8,80/1,40

m³ 1,70 - kg. 73

Central elements

Central
Chauffeuses

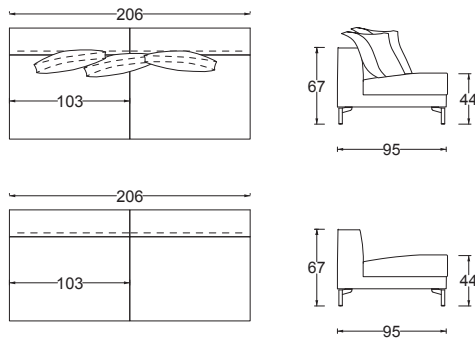

Description Descripción Description	Code Código Code	Side Lado Côté	Fabrics - Telas - Tissu				Leather - Piel - Cuir			C.O.M. fabric L./H. Tela cliente L./A. Tissu client L./H.	
			Cat. B	Cat. C/D	Cat. Must	Cat. K	Cat. E	Cat. Plus	Cat. Luxury		
Composition Composición Composition	35FCP3N 206 + 3x 35FEPBN 58x55		2.900	3.095	3.290	3.490	4.625	5.590	6.350	2.900	11,41/1,40
Feather Pluma - Plume	35FCP3N 206		2.420	2.555	2.690	2.830	3.650	4.330	4.880	2.420	9,35/1,40
Cover Revest. - Housse	C60CE3N 206		650	790	930	1.080	-	-	-	650	9,35/1,40

m² 1,85 - kg. 78

Chaise longues

Chaise longues - Chaise Longue

LH / IZDA / G.

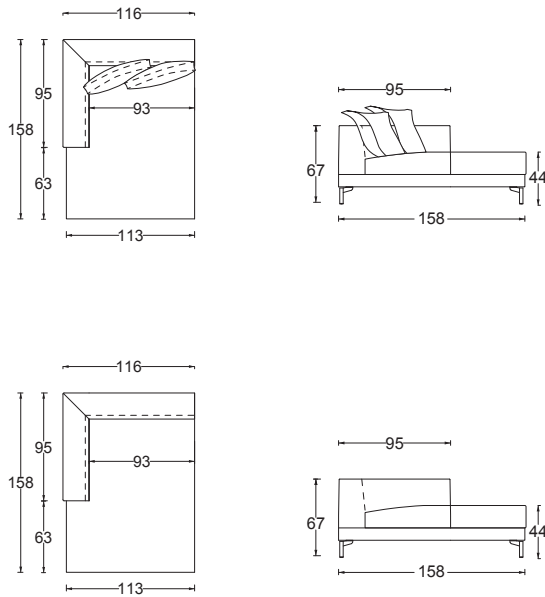

Description Descripción Description	Code Código Code	Side Lado Côté	Fabrics - Telas - Tissu				Leather - Piel - Cuir			C.O.M. fabric L./H. Tela cliente L./A. Tissu client L./H.	
			Cat. B	Cat. C/D	Cat. Must	Cat. K	Cat. E	Cat. Plus	Cat. Luxury		
Composition Composición Composition	35FCP5S/R 116 + 2x 35FEPBN 58x55	LH / IZDA / G. RH / DCHA / D.	2.505	2.660	2.815	2.980	3.880	4.655	5.260	2.505	7,76/1,40

Description Descripción Description	Code Código Code	Side Lado Côté	Fabrics - Telas - Tissu				Leather - Piel - Cuir			C.O.M. fabric L./H. Tela cliente L./A. Tissu client L./H.	
			Cat. B	Cat. C/D	Cat. Must	Cat. K	Cat. E	Cat. Plus	Cat. Luxury		
Feather Pluma - Plume	35FCP5S 116 35FCP5R 116	LH / IZDA / G. RH / DCHA / D.	2.185	2.300	2.415	2.540	3.230	3.815	4.280	2.185	6,60/1,40
Cover Revest. - Housse	C5FCE5S 116 C5FCE5R 116	LH / IZDA / G. RH / DCHA / D.	585	710	840	970	-	-	-	585	6,60/1,40

m² 2,20 - kg. 90

Dormeuse

Meridienne - Méridienne

LH / IZDA / G.

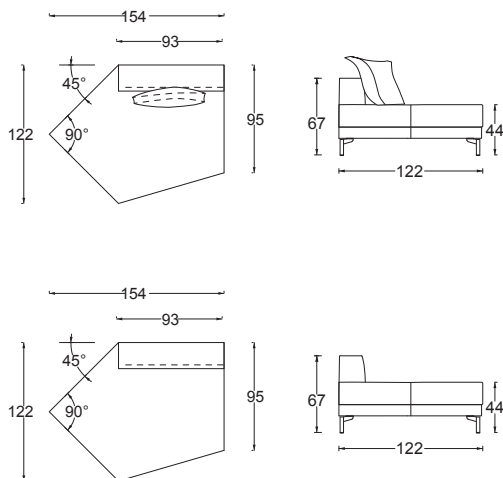

Description Descripción Description	Code Código Code	Side Lado Côté	Fabrics - Telas - Tissu				Leather - Piel - Cuir			C.O.M. fabric L./H. Tela cliente L./A. Tissu client L./H.	
			Cat. B	Cat. C/D	Cat. Must	Cat. K	Cat. E	Cat. Plus	Cat. Luxury		
Composition Composición Composition	35FCP7S/R 154 + 35FEPBN 58x55	LH / IZDA / G. RH / DCHA / D.	2.180	2.295	2.415	2.530	3.225	3.810	4.270	2.180	7,04/1,40

Description Descripción Description	Code Código Code	Side Lado Côté	Fabrics - Telas - Tissu				Leather - Piel - Cuir			C.O.M. fabric L./H. Tela cliente L./A. Tissu client L./H.	
			Cat. B	Cat. C/D	Cat. Must	Cat. K	Cat. E	Cat. Plus	Cat. Luxury		
Feather Pluma - Plume	35FCP7S 154 35FCP7R 154	LH / IZDA / G. RH / DCHA / D.	2.020	2.115	2.215	2.310	2.900	3.390	3.780	2.020	5,50/1,40
Cover Revest. - Housse	C5FCE7S 154 C5FCE7R 154	LH / IZDA / G. RH / DCHA / D.	540	650	765	890	-	-	-	540	5,50/1,40

m² 1,10 - kg. 45

Footstool

Puff
Pouf

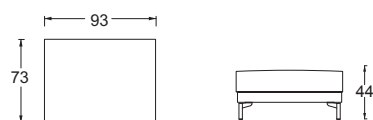

Description Descripción Description	Code Código Code	Side Lado Côté	Fabrics - Telas - Tissu				Leather - Piel - Cuir			C.O.M. fabric L./H. Tela cliente L./A. Tissu client L./H.	
			Cat. B	Cat. C/D	Cat. Must	Cat. K	Cat. E	Cat. Plus	Cat. Luxury		
Feather Pluma - Plume	35FCP8N 073		1.345	1.390	1.430	1.475	1.735	1.955	2.130	1.345	1,76/1,40
Cover Revest. - Housse	C5FCE8N 073		360	430	495	570	-	-	-	360	1,76/1,40

m³ 1,60 - kg. 60

Footstool

Puff
Pouf

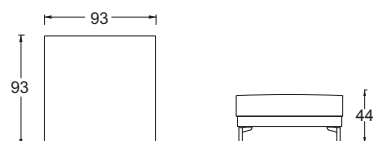

Description Descripción Description	Code Código Code	Side Lado Côté	Fabrics - Telas - Tissu				Leather - Piel - Cuir			C.O.M. fabric L./H. Tela cliente L./A. Tissu client L./H.	
			Cat. B	Cat. C/D	Cat. Must	Cat. K	Cat. E	Cat. Plus	Cat. Luxury		
Feather Pluma - Plume	35FCP8N 093		1.495	1.540	1.590	1.640	1.925	2.165	2.355	1.495	2,20/1,40
Cover Revest. - Housse	C5FCE8N 093		405	475	550	630	-	-	-	405	2,20/1,40

m³ 1,70 - kg. 65

Back cushion 58x55

Cojines de respaldo
Coussins de dossier



Description Descripción Description	Code Código Code	Side Lado Côté	Fabrics - Telas - Tissu				Leather - Piel - Cuir			C.O.M. fabric L./H. Tela cliente L./A. Tissu client L./H.	
			Cat. B	Cat. C/D	Cat. Must	Cat. K	Cat. E	Cat. Plus	Cat. Luxury		
Feather Pluma - Plume	35FEPCN 58x55		160	180	200	220	325	420	490	160	0,70/1,40
Cover Revest. - Housse	C5FEECN 58x55		70	85	100	110	-	-	-	70	0,70/1,40

m³ 0,12 - kg. 2,9

Back cushion with rollò 58x55

Cojín de respaldo con rollò
Coussin de dossier avec Rollò

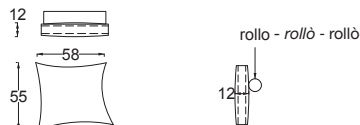

Description Descripción Description	Code Código Code	Side Lado Côté	Fabrics - Telas - Tissu				Leather - Piel - Cuir			C.O.M. fabric L./H. Tela cliente L./A. Tissu client L./H.	
			Cat. B	Cat. C/D	Cat. Must	Cat. K	Cat. E	Cat. Plus	Cat. Luxury		
Feather Pluma - Plume	35FEPBN 058R		190	205	235	260	385	495	585	190	1,20/1,40
Cover Revest. - Housse	C5FEEBN 058R		80	100	120	140	-	-	-	80	1,20/1,40

m³ 0,40 - kg. 3,9

Back cushion 73x51

Cojines de respaldo
Coussins de dossier

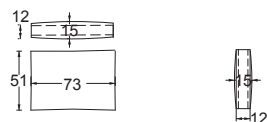

Description Descripción Description	Code Código Code	Side Lado Côté	Fabrics - Telas - Tissu				Leather - Piel - Cuir			C.O.M. fabric L./H. Tela cliente L./A. Tissu client L./H.	
			Cat. B	Cat. C/D	Cat. Must	Cat. K	Cat. E	Cat. Plus	Cat. Luxury		
Feather Pluma - Plume	35FEPCN 073		185	200	220	245	360	465	545	185	0,95/1,40
Cover Revest. - Housse	C5FEECN 073		75	90	105	125	-	-	-	75	0,95/1,40

m³ 0,15 - kg. 3,7

Back cushion with rollò 73x51

Cojín de respaldo con rollò
Coussin de dossier avec Rollò

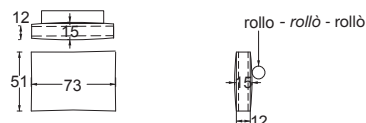

Description Descripción Description	Code Código Code	Side Lado Côté	Fabrics - Telas - Tissu				Leather - Piel - Cuir			C.O.M. fabric L./H. Tela cliente L./A. Tissu client L./H.	
			Cat. B	Cat. C/D	Cat. Must	Cat. K	Cat. E	Cat. Plus	Cat. Luxury		
Feather Pluma - Plume	35FEPCN 073R		215	235	260	290	425	545	640	215	1,45/1,40
Cover Revest. - Housse	C5FEECN 073R		90	110	135	155	-	-	-	90	1,45/1,40

m³ 0,17 - kg. 4,7

Back cushion 83x51

Cojines de respaldo
Coussins de dossier

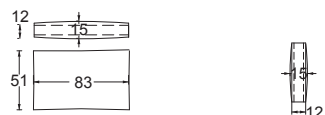

Description Descripción Description	Code Código Code	Side Lado Côté	Fabrics - <i>Telas</i> - Tissu				Leather - <i>Piel</i> - Cuir			C.O.M. fabric L./H. <i>Tela cliente L./A.</i> Tissu client L./H.	
			Cat. B	Cat. C/D	Cat. Must	Cat. K	Cat. E	Cat. Plus	Cat. Luxury		
Feather <i>Pluma</i> - Plume	35FEPCN 083		190	210	240	265	395	505	590	190	0,95/1,40
Cover <i>Revest.</i> - Housse	C5FEECN 083		80	95	120	135	-	-	-	80	0,95/1,40

m³ 0,15 - kg. 4,3

Back cushion with rollò 83x51

Cojín de respaldo con rollò
Coussin de dossier avec Rollò



Description Descripción Description	Code Código Code	Side Lado Côté	Fabrics - <i>Telas</i> - Tissu				Leather - <i>Piel</i> - Cuir			C.O.M. fabric L./H. <i>Tela cliente L./A.</i> Tissu client L./H.	
			Cat. B	Cat. C/D	Cat. Must	Cat. K	Cat. E	Cat. Plus	Cat. Luxury		
Feather <i>Pluma</i> - Plume	35FEPCN 083R		220	245	270	300	440	570	670	220	1,45/1,40
Cover <i>Revest.</i> - Housse	C5FEECN 083R		95	120	140	160	-	-	-	95	1,45/1,40

m³ 0,17 - kg. 5,3

Back cushion 93x51

Cojines de respaldo
Coussins de dossier

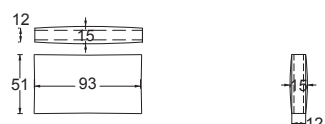

Description Descripción Description	Code Código Code	Side Lado Côté	Fabrics - <i>Telas</i> - Tissu				Leather - <i>Piel</i> - Cuir			C.O.M. fabric L./H. <i>Tela cliente L./A.</i> Tissu client L./H.	
			Cat. B	Cat. C/D	Cat. Must	Cat. K	Cat. E	Cat. Plus	Cat. Luxury		
Feather <i>Pluma</i> - Plume	35FEPCN 093		200	220	250	275	410	525	620	200	1,05/1,40
Cover <i>Revest.</i> - Housse	C5FEECN 093		85	105	130	145	-	-	-	85	1,05/1,40

m³ 0,18 - kg. 4,8

Back cushion with rollò 93x51

Cojín de respaldo con rollò
Coussin de dossier avec Rollò



Description Descripción Description	Code Código Code	Side Lado Côté	Fabrics - <i>Telas</i> - Tissu				Leather - <i>Piel</i> - Cuir			C.O.M. fabric L./H. <i>Tela cliente L./A.</i> Tissu client L./H.	
			Cat. B	Cat. C/D	Cat. Must	Cat. K	Cat. E	Cat. Plus	Cat. Luxury		
Feather <i>Pluma</i> - Plume	35FEPCN 093R		235	255	290	320	475	615	715	235	1,55/1,40
Cover <i>Revest.</i> - Housse	C5FEECN 093R		100	125	145	175	-	-	-	100	1,55/1,40

m³ 0,20 - kg. 5,8

Back cushion 103x51

Cojines de respaldo
Coussins de dossier

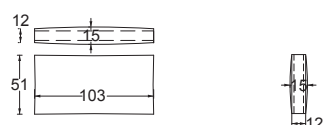

Description Descripción Description	Code Código Code	Side Lado Côté	Fabrics - <i>Telas</i> - Tissu				Leather - <i>Piel</i> - Cuir			C.O.M. fabric L./H. <i>Tela cliente L./A.</i> Tissu client L./H.	
			Cat. B	Cat. C/D	Cat. Must	Cat. K	Cat. E	Cat. Plus	Cat. Luxury		
Feather <i>Pluma</i> - Plume	35FEPCN 103		210	235	260	290	425	545	640	210	1,15/1,40
Cover <i>Revest.</i> - Housse	C5FEECN 103		90	110	135	155	-	-	-	90	1,15/1,40

m³ 0,20 - kg. 5,3

Back cushion with rollò 103x51

Cojín de respaldo con rollò
Coussin de dossier avec Rollò

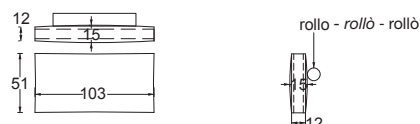

Description Descripción Description	Code Código Code	Side Lado Côté	Fabrics - <i>Telas</i> - Tissu				Leather - <i>Piel</i> - Cuir			C.O.M. fabric L./H. <i>Tela cliente L./A.</i> Tissu client L./H.	
			Cat. B	Cat. C/D	Cat. Must	Cat. K	Cat. E	Cat. Plus	Cat. Luxury		
Feather <i>Pluma</i> - Plume	35FEPCN 103R		250	270	305	340	495	640	750	250	1,65/1,40
Cover <i>Revest.</i> - Housse	C5FEECN 103R		105	130	155	185	-	-	-	105	1,65/1,40

m³ 0,22 - kg. 6,3

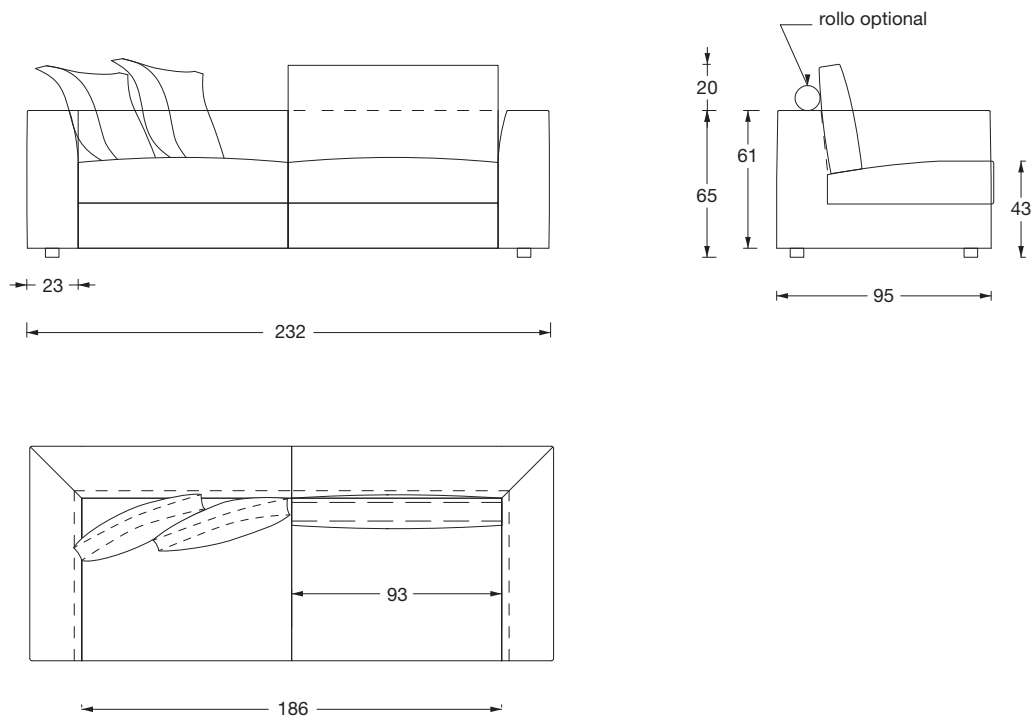

<p>Base seat</p> <p>plywood and solid poplar and fir elastic belts 6/8 cm cross weft pressed polyester fibre</p> <p>Seat</p> <p>goose feather blend polyurethane D35 IM polyurethane D25 FR</p> <p>Backrest</p> <p>wood fibre polyurethane D40 IM polyurethane D28</p> <p>Backrest cushion</p> <p>blend of goose feather and silicone fibre 100% cotton fabric</p> <p>Armrest</p> <p>wood fibre polyurethane D40 IPP polyurethane D21 IM pressed polyester fibre</p> <p>Feet</p> <p>wood</p>	<p><i>Base asiento</i></p> <p><i>contrachapado y macizo de álamo y abeto tirantes elásticos cruzados de 6/8 cm fibra de poliéster prensada</i></p> <p><i>Asiento</i></p> <p><i>mezcla de pluma de ganso poliuretano D35 IM poliuretano D25 FR</i></p> <p><i>Respaldo</i></p> <p><i>fibra de madera poliuretano D40 IM poliuretano D28</i></p> <p><i>Cojín del respaldo</i></p> <p><i>mezcla de pluma de ganso y fibra de silicona tela 100% algodón</i></p> <p><i>Brazos</i></p> <p><i>fibra de madera poliuretano D40 IPP poliuretano D21 IM fibra de poliéster prensada</i></p> <p><i>Patas</i></p> <p><i>madera</i></p>	<p>Base assise</p> <p>contreplaqué en bois et bois massif de sapin et de peuplier sangles élastiques 6 et 8 cm croisées fibre de polyester pressée</p> <p>Assise</p> <p>mélange de duvet d'oie Polyuréthane D35 IM Polyuréthane D25 FR</p> <p>Dossier</p> <p>Polyuréthane D40 IM Polyuréthane D28</p> <p>Coussin de dossier</p> <p>mélange de duvet d'oie et de fibre de silicone tissu 100% coton</p> <p>Accoudoir</p> <p>fibre de bois polyuréthane D40 IPP polyuréthane D21 IM fibre de polyester pressée</p> <p>Pieds</p> <p>bois</p>
<p>Completely removable cover</p>	<p><i>Con funda removible</i></p>	<p>Housse amovible</p>

Headrest cushion

Cojín para reposacabezas
Coussin appui-tête

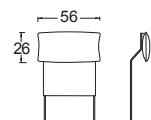

Description <i>Descripción</i> Description	Code <i>Código</i> Code	Side <i>Lado</i> Côté	Fabrics - <i>Telas</i> - Tissu				Leather - <i>Piel</i> - Cuir			C.O.M. fabric L./H. <i>Tela cliente L./A.</i> Tissu client L./H.	
			Cat. B	Cat. C/D	Cat. Must	Cat. K	Cat. E	Cat. Plus	Cat. Luxury		
Foam <i>Espuma</i> - Mousse	36MEEHN		215	230	245	260	350	425	485	215	0,90/1,40
Cover <i>Revest.</i> - Housse	C6MEEHN		65	80	95	115	205	280	340	65	0,90/1,40

m³ 0,09 - kg. 2,4

Sofas

Sofás
Canapés

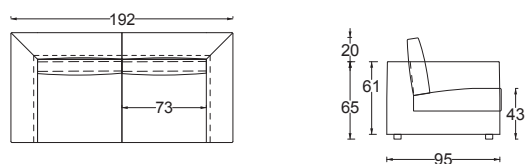

Description Descripción Description	Code Código Code	Side Lado Côté	Fabrics - Telas - Tissu				Leather - Piel - Cuir			C.O.M. fabric L./H. Tela cliente L./A. Tissu client L./H.	
			Cat. B	Cat. C/D	Cat. Must	Cat. K	Cat. E	Cat. Plus	Cat. Luxury		
Composition Composición Composition	360CP1N 192 + 2x 35FEPCN 073		2.715	2.865	3.035	3.205	4.170	4.995	5.650	2.715	10,72/1,40

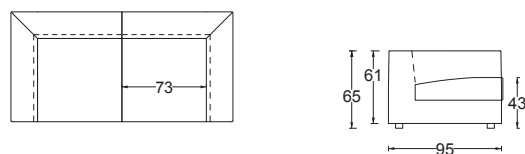

Feather Pluma - Plume	360CP1N 192		2.345	2.465	2.595	2.715	3.450	4.065	4.560	2.345	8,80/1,40
Cover Revest. - Housse	C60CE1N 192		690	825	975	1.125	-	-	-	690	8,80/1,40

m³ 1,70 - kg. 73

Sofas

Sofás
Canapés

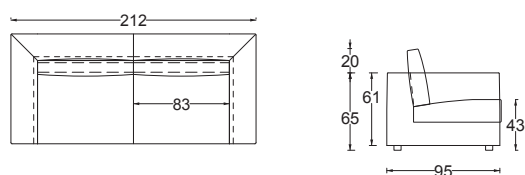

Description Descripción Description	Code Código Code	Side Lado Côté	Fabrics - Telas - Tissu				Leather - Piel - Cuir			C.O.M. fabric L./H. Tela cliente L./A. Tissu client L./H.	
			Cat. B	Cat. C/D	Cat. Must	Cat. K	Cat. E	Cat. Plus	Cat. Luxury		
Composition Composición Composition	360CP1N 212 + 2x 35FEPCN 083		2.825	2.990	3.175	3.355	4.385	5.240	5.925	2.825	11,47/1,40

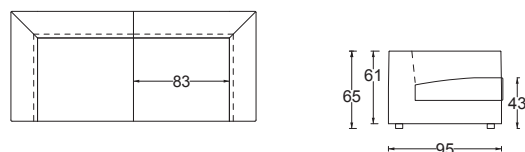

Feather Pluma - Plume	360CP1N 212		2.445	2.570	2.695	2.825	3.595	4.230	4.745	2.445	9,35/1,40
Cover Revest. - Housse	C60CE1N 212		715	860	1015	1170	-	-	-	715	9,35/1,40

m³ 1,85 - kg. 78

Sofas

Sofás
Canapés

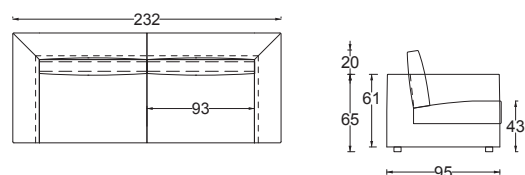

Description Descripción Description	Code Código Code	Side Lado Côté	Fabrics - Telas - Tissu				Leather - Piel - Cuir			C.O.M. fabric L./H. Tela cliente L./A. Tissu client L./H.	
			Cat. B	Cat. C/D	Cat. Must	Cat. K	Cat. E	Cat. Plus	Cat. Luxury		
Composition Composición Composition	360CP1N 232 + 2x 35FEPCN 093		2.920	3.095	3.285	3.465	4.535	5.430	6.150	2.920	12,22/1,40

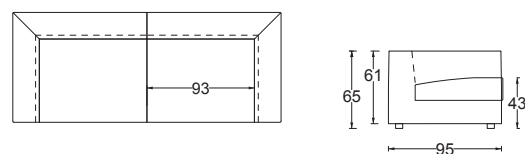

Feather Pluma - Plume	360CP1N 232		2.520	2.655	2.785	2.915	3.715	4.380	4.910	2.520	9,90/1,40
Cover Revest. - Housse	C60CE1N 232		735	890	1040	1200	-	-	-	735	9,90/1,40

m³ 2,00 - kg. 84

Sofas

Sofás
Canapés

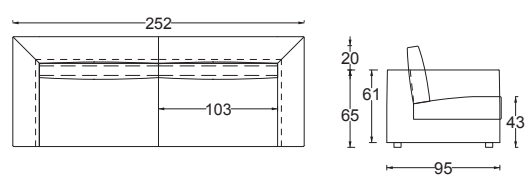

Description Descripción Description	Code Código Code	Side Lado Côté	Fabrics - Telas - Tissu				Leather - Piel - Cuir			C.O.M. fabric L./H. Tela cliente L./A. Tissu client L./H.	
			Cat. B	Cat. C/D	Cat. Must	Cat. K	Cat. E	Cat. Plus	Cat. Luxury		
Composition Composición Composition	360CP1N 252 + 2x 35FEPCN 103		3.020	3.200	3.390	3.585	4.675	5.595	6.335	3.020	12,97/1,40

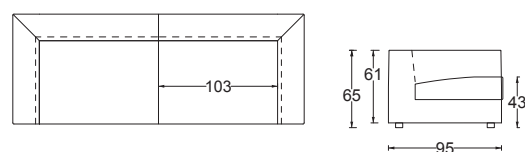

Feather Pluma - Plume	360CP1N 252		2.600	2.730	2.870	3.005	3.825	4.505	5.055	2.600	10,45/1,40
Cover Revest. - Housse	C60CE1N 252		755	910	1070	1235	-	-	-	755	10,45/1,40

m³ 2,20 - kg. 90

Side element

Lateral - Éléments latéraux

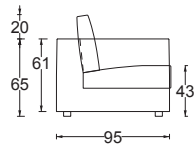
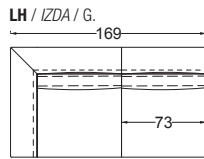

Description Descripción Description	Code Código Code	Side Lado Côté	Fabrics - Telas - Tissu				Leather - Piel - Cuir			C.O.M. fabric L./H. Tela cliente L./A. Tissu client L./H.	
			Cat. B	Cat. C/D	Cat. Must	Cat. K	Cat. E	Cat. Plus	Cat. Luxury		
Composition Composición Composition	360CP2S/R 169 + 2x 35FEPNCN 073	LH / IZDA / G. RH / DCHA / D.	2.430	2.565	2.705	2.865	3.720	4.445	5.030	2.430	9,94/1,40

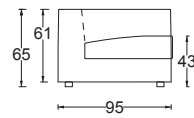
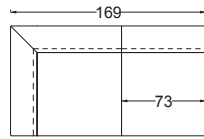

Feather Pluma - Plume	360CP2S 169 360CP2R 169	LH / IZDA / G. RH / DCHA / D.	2.060	2.165	2.265	2.375	3.000	3.515	3.940	2.060	8,25/1,40
Cover Revest. - Housse	C60CE2S 169 C60CE2R 169	LH / IZDA / G. RH / DCHA / D.	615	735	860	990	-	-	-	615	8,25/1,40

m³ 1,10 - kg. 45

Side element

Lateral - Éléments latéraux

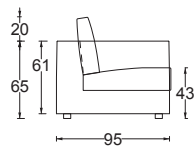
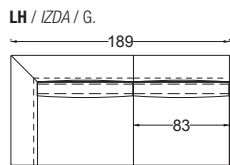

Description Descripción Description	Code Código Code	Side Lado Côté	Fabrics - Telas - Tissu				Leather - Piel - Cuir			C.O.M. fabric L./H. Tela cliente L./A. Tissu client L./H.	
			Cat. B	Cat. C/D	Cat. Must	Cat. K	Cat. E	Cat. Plus	Cat. Luxury		
Composition Composición Composition	360CP2S/R 189 + 2x 35FEPNCN 083	LH / IZDA / G. RH / DCHA / D.	2.520	2.670	2.835	2.995	3.910	4.675	5.280	2.520	10,69/1,40

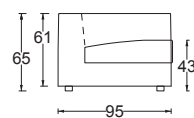
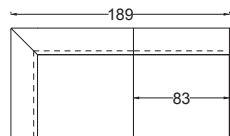

Feather Pluma - Plume	360CP2S 189 360CP2R 189	LH / IZDA / G. RH / DCHA / D.	2.140	2.250	2.355	2.465	3.120	3.665	4.100	2.140	8,80/1,40
Cover Revest. - Housse	C60CE2S 189 C60CE2R 189	LH / IZDA / G. RH / DCHA / D.	635	760	895	1030	-	-	-	635	8,80/1,40

m³ 1,60 - kg. 60

Side element

Lateral - Éléments latéraux

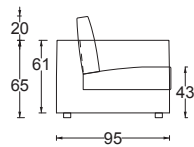
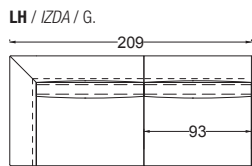

Description Descripción Description	Code Código Code	Side Lado Côté	Fabrics - Telas - Tissu				Leather - Piel - Cuir			C.O.M. fabric L./H. Tela cliente L./A. Tissu client L./H.	
			Cat. B	Cat. C/D	Cat. Must	Cat. K	Cat. E	Cat. Plus	Cat. Luxury		
Composition Composición Composition	360CP2S/R 209 + 2x 35FEPNCN 093	LH / IZDA / G. RH / DCHA / D.	2.625	2.780	2.950	3.115	4.055	4.845	5.485	2.625	11,44/1,40

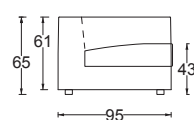
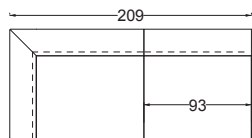

Feather Pluma - Plume	360CP2S 209 360CP2R 209	LH / IZDA / G. RH / DCHA / D.	2.225	2.340	2.450	2.565	3.235	3.795	4.245	2.225	9,35/1,40
Cover Revest. - Housse	C60CE2S 209 C60CE2R 209	LH / IZDA / G. RH / DCHA / D.	655	790	925	1070	-	-	-	655	9,35/1,40

m³ 1,70 - kg. 65

Side element

Lateral - Éléments latéraux

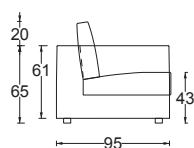
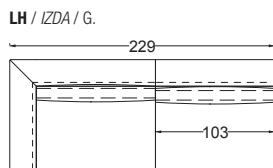

Description Descripción Description	Code Código Code	Side Lado Côté	Fabrics - Telas - Tissu				Leather - Piel - Cuir			C.O.M. fabric L./H. Tela cliente L./A. Tissu client L./H.	
			Cat. B	Cat. C/D	Cat. Must	Cat. K	Cat. E	Cat. Plus	Cat. Luxury		
Composition Composición Composition	360CP2S/R 229 + 2x 35FEPNCN 103	LH / IZDA / G. RH / DCHA / D.	2.720	2.885	3.050	3.230	4.195	5.015	5.665	2.720	12,19/1,40

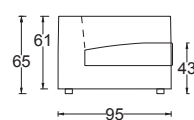
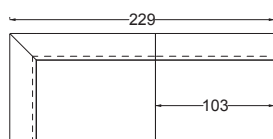

Feather Pluma - Plume	360CP2S 229 360CP2R 229	LH / IZDA / G. RH / DCHA / D.	2.300	2.415	2.530	2.650	3.345	3.925	4.385	2.300	9,90/1,40
Cover Revest. - Housse	C60CE2S 229 C60CE2R 229	LH / IZDA / G. RH / DCHA / D.	680	815	955	1095	-	-	-	680	9,90/1,40

m³ 1,80 - kg. 70

Central elements

Central

Chaqueuses

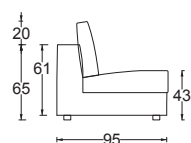
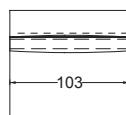

Description Descripción Description	Code Código Code	Side Lado Côté	Fabrics - <i>Telas</i> - Tissu				Leather - <i>Piel</i> - Cuir			C.O.M. fabric L./H. <i>Tela cliente L./A.</i> Tissu client L./H.	
			Cat. B	Cat. C/D	Cat. Must	Cat. K	Cat. E	Cat. Plus	Cat. Luxury		
Composition <i>Composición</i> Composition	360CP3N 103 +		1.515	1.630	1.740	1.865	2.540	3.110	3.570	1.515	5,98/1,40
	35FEPCN 103										

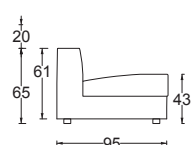
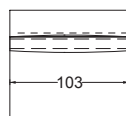

Feather <i>Pluma</i> - Plume	360CP3N 103		1.305	1.395	1.480	1.575	2.115	2.565	2.930	1.305	4,95/1,40
Cover <i>Revest.</i> - Housse	C60CE3N 103		490	590	695	805	-	-	-	490	4,95/1,40

m³ 2,00 - kg. 84

Central elements

Central

Chaqueuses

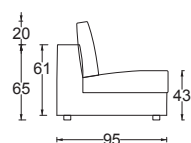
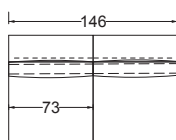

Description Descripción Description	Code Código Code	Side Lado Côté	Fabrics - <i>Telas</i> - Tissu				Leather - <i>Piel</i> - Cuir			C.O.M. fabric L./H. <i>Tela cliente L./A.</i> Tissu client L./H.	
			Cat. B	Cat. C/D	Cat. Must	Cat. K	Cat. E	Cat. Plus	Cat. Luxury		
Composition <i>Composición</i> Composition	360CP3N 146 +		2.090	2.240	2.405	2.575	3.545	4.370	5.025	2.090	9,16/1,40
	2x 35FEPCN 073										

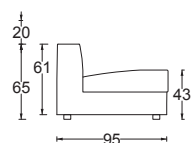
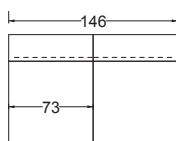

Feather <i>Pluma</i> - Plume	360CP3N 146		1.720	1.840	1.965	2.085	2.825	3.440	3.935	1.720	7,70/1,40
Cover <i>Revest.</i> - Housse	C60CE3N 146		580	705	840	970	-	-	-	580	7,70/1,40

m³ 1,90 - kg. 75

Central elements

Central

Chaqueuses

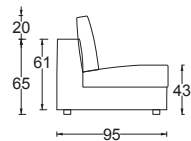
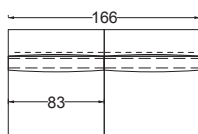

Description Descripción Description	Code Código Code	Side Lado Côté	Fabrics - <i>Telas</i> - Tissu				Leather - <i>Piel</i> - Cuir			C.O.M. fabric L./H. <i>Tela cliente L./A.</i> Tissu client L./H.	
			Cat. B	Cat. C/D	Cat. Must	Cat. K	Cat. E	Cat. Plus	Cat. Luxury		
Composition <i>Composición</i> Composition	360CP3N 166 +		2.195	2.365	2.550	2.725	3.755	4.615	5.295	2.195	9,91/1,40
	2x 35FEPCN 083										

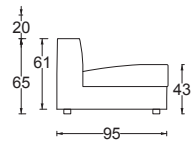
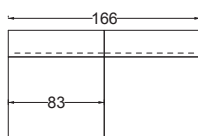

Feather <i>Pluma</i> - Plume	360CP3N 166		1.815	1.945	2.070	2.195	2.965	3.605	4.115	1.815	8,25/1,40
Cover <i>Revest.</i> - Housse	C60CE3N 166		605	740	870	1.015	-	-	-	605	8,25/1,40

m³ 1,70 - kg. 60

Central elements

Central

Chaqueuses

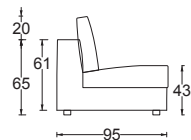
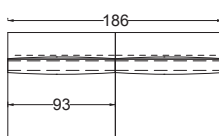

Description Descripción Description	Code Código Code	Side Lado Côté	Fabrics - <i>Telas</i> - Tissu				Leather - <i>Piel</i> - Cuir			C.O.M. fabric L./H. <i>Tela cliente L./A.</i> Tissu client L./H.	
			Cat. B	Cat. C/D	Cat. Must	Cat. K	Cat. E	Cat. Plus	Cat. Luxury		
Composition <i>Composición</i> Composition	360CP3N 186 +		2.295	2.465	2.660	2.840	3.910	4.805	5.520	2.295	10,66/1,40
	2x 35FEPCN 093										

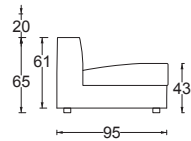
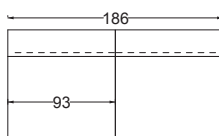

Feather <i>Pluma</i> - Plume	360CP3N 186		1.895	2.025	2.160	2.290	3.090	3.755	4.280	1.895	8,80/1,40
Cover <i>Revest.</i> - Housse	C60CE3N 186		630	760	905	1045	-	-	-	630	8,80/1,40

m³ 1,70 - kg. 73

Central elements

Central

Chauffeuses

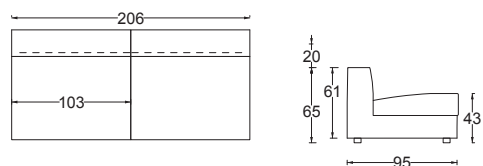
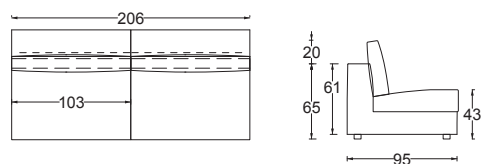

Description Descripción Description	Code Código Code	Side Lado Côté	Fabrics - Telas - Tissu				Leather - Piel - Cuir			C.O.M. fabric L./H. Tela cliente L./A. Tissu client L./H.	
			Cat. B	Cat. C/D	Cat. Must	Cat. K	Cat. E	Cat. Plus	Cat. Luxury		
Composition Composición Composition	360CP3N 206 + 2x 35FEPCN 103		2.390	2.575	2.760	2.960	4.050	4.970	5.710	2.390	11,41/1,40
Feather Pluma - Plume	360CP3N 206		1.970	2.105	2.240	2.380	3.200	3.880	4.430	1.970	9,35/1,40
Cover Revest. - Housse	C60CE3N 206		650	790	930	1.080	-	-	-	650	9,35/1,40

m³ 1,85 - kg. 78

Chaise longues

Chaise longues - Chaise Longue

LH / IZDA / G.

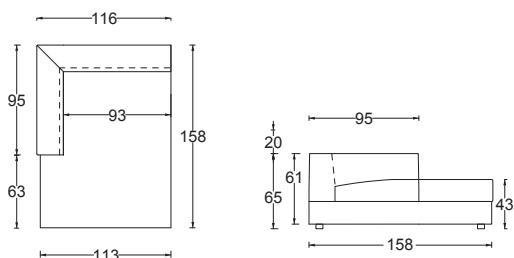
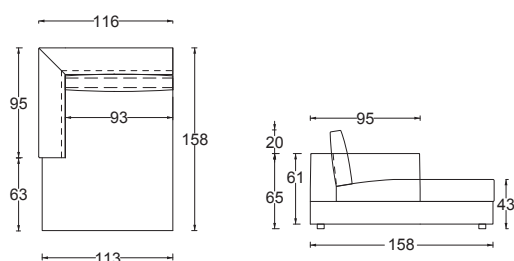

Description Descripción Description	Code Código Code	Side Lado Côté	Fabrics - Telas - Tissu				Leather - Piel - Cuir			C.O.M. fabric L./H. Tela cliente L./A. Tissu client L./H.	
			Cat. B	Cat. C/D	Cat. Must	Cat. K	Cat. E	Cat. Plus	Cat. Luxury		
Composition Composición Composition	360CP5S/R 116 + 35FEPCN 093	LH / IZDA / G. RH / DCHA / D.	2.160	2.295	2.440	2.585	3.415	4.115	4.675	2.360	7,76/1,40

Description Descripción Description	Code Código Code	Side Lado Côté	Fabrics - Telas - Tissu				Leather - Piel - Cuir			C.O.M. fabric L./H. Tela cliente L./A. Tissu client L./H.	
			Cat. B	Cat. C/D	Cat. Must	Cat. K	Cat. E	Cat. Plus	Cat. Luxury		
Feather Pluma - Plume	360CP5S 116 360CP5R 116	LH / IZDA / G. RH / DCHA / D.	1.960	2.075	2.190	2.310	3.005	3.590	4.055	1.960	6,60/1,40
Cover Revest. - Housse	C60CE5S 116 C60CE5R 116	LH / IZDA / G. RH / DCHA / D.	585	710	840	970	-	-	-	585	6,60/1,40

m³ 2,20 - kg. 90

Dormeuse

Meridienne - Méridienne

LH / IZDA / G.

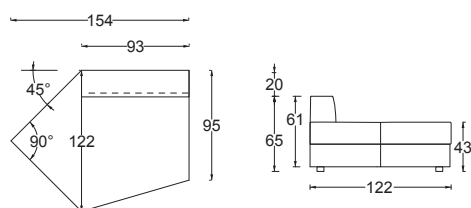
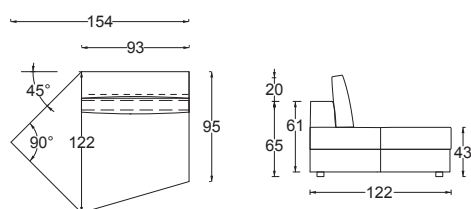

Description Descripción Description	Code Código Code	Side Lado Côté	Fabrics - Telas - Tissu				Leather - Piel - Cuir			C.O.M. fabric L./H. Tela cliente L./A. Tissu client L./H.	
			Cat. B	Cat. C/D	Cat. Must	Cat. K	Cat. E	Cat. Plus	Cat. Luxury		
Composition Composición Composition	360CP7S/R 154 + 35FEPCN 093	LH / IZDA / G. RH / DCHA / D.	1.995	2.110	2.240	2.360	3.085	3.690	4.175	1.995	7,04/1,40

Description Descripción Description	Code Código Code	Side Lado Côté	Fabrics - Telas - Tissu				Leather - Piel - Cuir			C.O.M. fabric L./H. Tela cliente L./A. Tissu client L./H.	
			Cat. B	Cat. C/D	Cat. Must	Cat. K	Cat. E	Cat. Plus	Cat. Luxury		
Feather Pluma - Plume	360CP7S 154 360CP7R 154	LH / IZDA / G. RH / DCHA / D.	1.795	1.890	1.990	2.085	2.675	3.165	3.555	1.795	5,50/1,40
Cover Revest. - Housse	C60CE7S 154 C60CE7R 154	LH / IZDA / G. RH / DCHA / D.	540	650	765	890	-	-	-	540	5,50/1,40

m³ 1,10 - kg. 45

Sofas

Sofás
Canapés

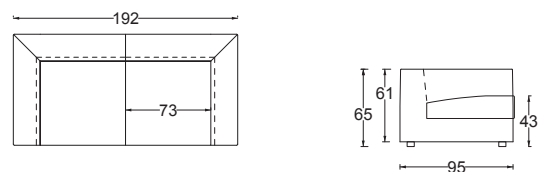
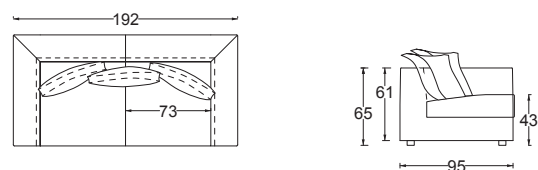

Description Descripción Description	Code Código Code	Side Lado Côté	Fabrics - Telas - Tissu				Leather - Piel - Cuir			C.O.M. fabric L./H. Tela cliente L./A. Tissu client L./H.	
			Cat. B	Cat. C/D	Cat. Must	Cat. K	Cat. E	Cat. Plus	Cat. Luxury		
Composition Composición Composition	360CP1N 192 + 3x 35FEPBN 58x55		2.825	3.005	3.195	3.375	4.425	5.325	6.030	2.825	10,72/1,40
Feather Pluma - Plume	360CP1N 192		2.345	2.465	2.595	2.715	3.450	4.065	4.560	2.345	8,80/1,40
Cover Revest. - Housse	C60CE1N 192		690	825	975	1.125	-	-	-	690	8,80/1,40

m³ 1,70 - kg. 73

Sofas

Sofás
Canapés

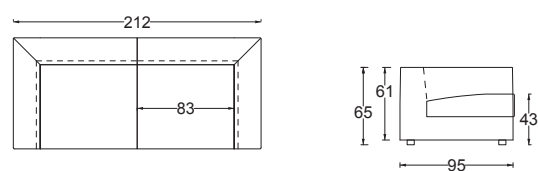
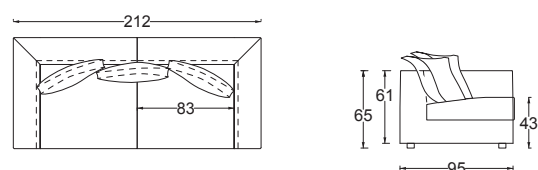

Description Descripción Description	Code Código Code	Side Lado Côté	Fabrics - Telas - Tissu				Leather - Piel - Cuir			C.O.M. fabric L./H. Tela cliente L./A. Tissu client L./H.	
			Cat. B	Cat. C/D	Cat. Must	Cat. K	Cat. E	Cat. Plus	Cat. Luxury		
Composition Composición Composition	360CP1N 212 + 3x 35FEPBN 58x55		2.925	3.110	3.295	3.485	4.570	5.490	6.215	2.925	11,47/1,40
Feather Pluma - Plume	360CP1N 212		2.445	2.570	2.695	2.825	3.595	4.230	4.745	2.445	9,35/1,40
Cover Revest. - Housse	C60CE1N 212		715	860	1015	1170	-	-	-	715	9,35/1,40

m³ 1,85 - kg. 78

Sofas

Sofás
Canapés

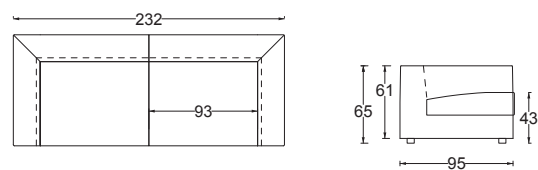
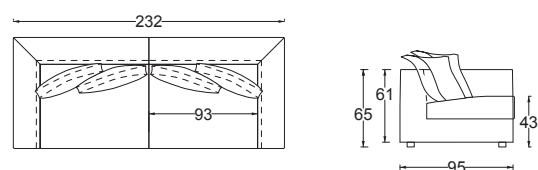

Description Descripción Description	Code Código Code	Side Lado Côté	Fabrics - Telas - Tissu				Leather - Piel - Cuir			C.O.M. fabric L./H. Tela cliente L./A. Tissu client L./H.	
			Cat. B	Cat. C/D	Cat. Must	Cat. K	Cat. E	Cat. Plus	Cat. Luxury		
Composition Composición Composition	360CP1N 232 + 4x 35FEPBN 58x55		3.160	3.375	3.585	3.795	5.015	6.060	6.870	3.160	12,22/1,40
Feather Pluma - Plume	360CP1N 232		2.520	2.655	2.785	2.915	3.715	4.380	4.910	2.520	9,90/1,40
Cover Revest. - Housse	C60CE1N 232		735	890	1040	1200	-	-	-	735	9,90/1,40

m³ 2,00 - kg. 84

Sofas

Sofás
Canapés

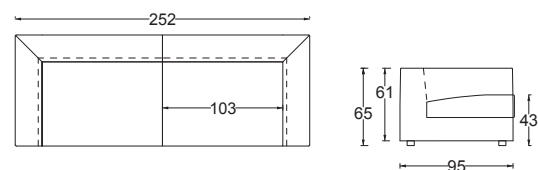
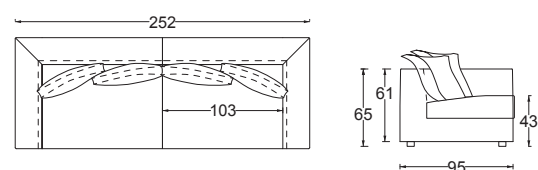

Description Descripción Description	Code Código Code	Side Lado Côté	Fabrics - Telas - Tissu				Leather - Piel - Cuir			C.O.M. fabric L./H. Tela cliente L./A. Tissu client L./H.	
			Cat. B	Cat. C/D	Cat. Must	Cat. K	Cat. E	Cat. Plus	Cat. Luxury		
Composition Composición Composition	360CP1N 252 + 4x 35FEPBN 58x55		3.240	3.450	3.670	3.885	5.125	6.185	7.015	3.240	12,97/1,40
Feather Pluma - Plume	360CP1N 252		2.600	2.730	2.870	3.005	3.825	4.505	5.055	2.600	10,45/1,40
Cover Revest. - Housse	C60CE1N 252		755	910	1070	1235	-	-	-	755	10,45/1,40

m³ 2,20 - kg. 90

Side element

Lateral - Éléments latéraux

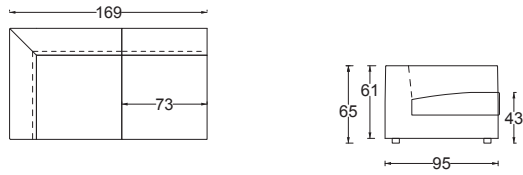
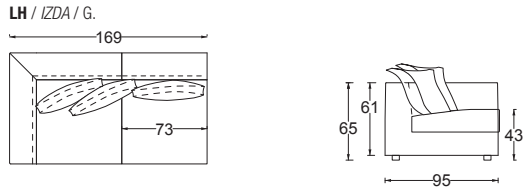

Description Descripción Description	Code Código Code	Side Lado Côté	Fabrics - Telas - Tissu				Leather - Piel - Cuir			C.O.M. fabric L./H. Tela cliente L./A. Tissu client L./H.	
			Cat. B	Cat. C/D	Cat. Must	Cat. K	Cat. E	Cat. Plus	Cat. Luxury		
Composition Composición Composition	360CP2S/R 169 + 3x 35FEPBN 58x55	LH / IZDA / G. RH / DCHA / D.	2.540	2.705	2.865	3.035	3.975	4.775	5.410	2.540	9,94/1,40
Feather Pluma - Plume	360CP2S 169 360CP2R 169	LH / IZDA / G. RH / DCHA / D.	2.060	2.165	2.265	2.375	3.000	3.515	3.940	2.060	8,25/1,40
Cover Revest. - Housse	C60CE2S 169 C60CE2R 169	LH / IZDA / G. RH / DCHA / D.	615	735	860	990	-	-	-	615	8,25/1,40

m³ 1,10 - kg. 45

Side element

Lateral - Éléments latéraux

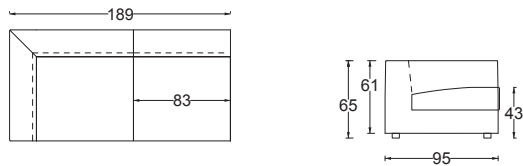
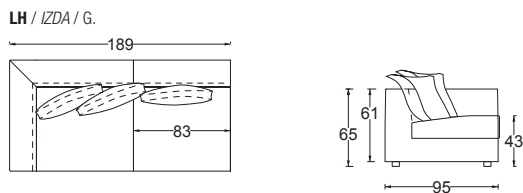

Description Descripción Description	Code Código Code	Side Lado Côté	Fabrics - Telas - Tissu				Leather - Piel - Cuir			C.O.M. fabric L./H. Tela cliente L./A. Tissu client L./H.	
			Cat. B	Cat. C/D	Cat. Must	Cat. K	Cat. E	Cat. Plus	Cat. Luxury		
Composition Composición Composition	360CP2S/R 189 + 3x 35FEPBN 58x55	LH / IZDA / G. RH / DCHA / D.	2.620	2.790	2.955	3.125	4.095	4.925	5.570	2.620	10,69/1,40
Feather Pluma - Plume	360CP2S 189 360CP2R 189	LH / IZDA / G. RH / DCHA / D.	2.140	2.250	2.355	2.465	3.120	3.665	4.100	2.140	8,80/1,40
Cover Revest. - Housse	C60CE2S 189 C60CE2R 189	LH / IZDA / G. RH / DCHA / D.	635	760	895	1030	-	-	-	635	8,80/1,40

m³ 1,60 - kg. 60

Side element

Lateral - Éléments latéraux

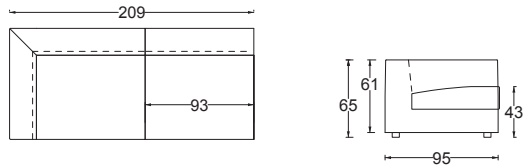
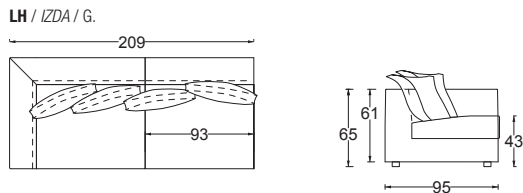

Description Descripción Description	Code Código Code	Side Lado Côté	Fabrics - Telas - Tissu				Leather - Piel - Cuir			C.O.M. fabric L./H. Tela cliente L./A. Tissu client L./H.	
			Cat. B	Cat. C/D	Cat. Must	Cat. K	Cat. E	Cat. Plus	Cat. Luxury		
Composition Composición Composition	360CP2S/R 209 + 4x 35FEPBN 58x55	LH / IZDA / G. RH / DCHA / D.	2.865	3.060	3.250	3.445	4.535	5.475	6.205	2.865	11,44/1,40
Feather Pluma - Plume	360CP2S 209 360CP2R 209	LH / IZDA / G. RH / DCHA / D.	2.225	2.340	2.450	2.565	3.235	3.795	4.245	2.225	9,35/1,40
Cover Revest. - Housse	C60CE2S 209 C60CE2R 209	LH / IZDA / G. RH / DCHA / D.	655	790	925	1070	-	-	-	655	9,35/1,40

m³ 1,70 - kg. 65

Side element

Lateral - Éléments latéraux

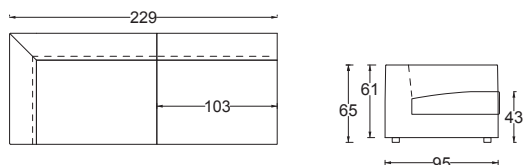
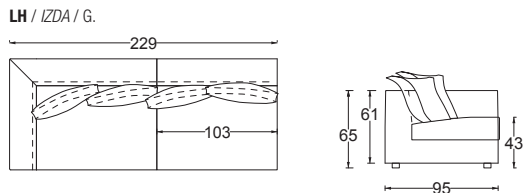

Description Descripción Description	Code Código Code	Side Lado Côté	Fabrics - Telas - Tissu				Leather - Piel - Cuir			C.O.M. fabric L./H. Tela cliente L./A. Tissu client L./H.	
			Cat. B	Cat. C/D	Cat. Must	Cat. K	Cat. E	Cat. Plus	Cat. Luxury		
Composition Composición Composition	360CP2S/R 229 + 4x 35FEPBN 58x55	LH / IZDA / G. RH / DCHA / D.	2.940	3.135	3.330	3.530	4.645	5.605	6.345	2.940	12,19/1,40
Feather Pluma - Plume	360CP2S 229 360CP2R 229	LH / IZDA / G. RH / DCHA / D.	2.300	2.415	2.530	2.650	3.345	3.925	4.385	2.300	9,90/1,40
Cover Revest. - Housse	C60CE2S 229 C60CE2R 229	LH / IZDA / G. RH / DCHA / D.	680	815	955	1095	-	-	-	680	9,90/1,40

m³ 1,80 - kg. 70

Central elements

Central

Chaqueuses

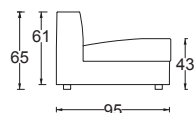
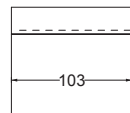
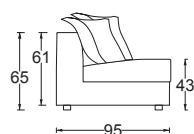
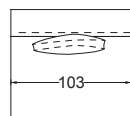

Description Descripción Description	Code Código Code	Side Lado Côté	Fabrics - <i>Telas</i> - Tissu				Leather - <i>Piel</i> - Cuir			C.O.M. fabric L./H. Tela cliente L./A. Tissu client L./H.	
			Cat. B	Cat. C/D	Cat. Must	Cat. K	Cat. E	Cat. Plus	Cat. Luxury		
Composition Composición Composition	360CP3N 103 + 35FEPBN 58x55		1.465	1.575	1.680	1.795	2.440	2.985	3.420	1.465	5,98/1,40
Feather Pluma - Plume	360CP3N 103		1.305	1.395	1.480	1.575	2.115	2.565	2.930	1.305	4,95/1,40
Cover Revest. - Housse	C60CE3N 103		490	590	695	805	-	-	-	490	4,95/1,40

m³ 2,00 - kg. 84

Central elements

Central

Chaqueuses

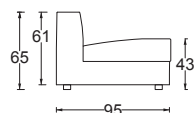
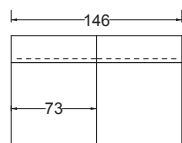
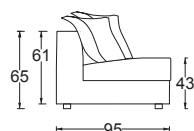
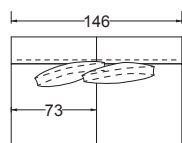

Description Descripción Description	Code Código Code	Side Lado Côté	Fabrics - <i>Telas</i> - Tissu				Leather - <i>Piel</i> - Cuir			C.O.M. fabric L./H. Tela cliente L./A. Tissu client L./H.	
			Cat. B	Cat. C/D	Cat. Must	Cat. K	Cat. E	Cat. Plus	Cat. Luxury		
Composition Composición Composition	360CP3N 146 + 2x 35FEPBN 58x55		2.040	2.200	2.365	2.525	3.475	4.280	4.915	2.040	9,16/1,40
Feather Pluma - Plume	360CP3N 146		1.720	1.840	1.965	2.085	2.825	3.440	3.935	1.720	7,70/1,40
Cover Revest. - Housse	C60CE3N 146		580	705	840	970	-	-	-	580	7,70/1,40

m³ 1,90 - kg. 75

Central elements

Central

Chaqueuses

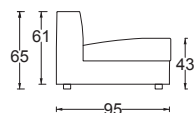
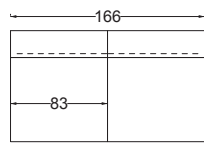
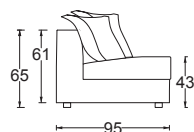
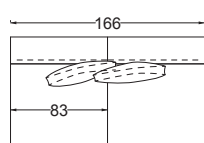

Description Descripción Description	Code Código Code	Side Lado Côté	Fabrics - <i>Telas</i> - Tissu				Leather - <i>Piel</i> - Cuir			C.O.M. fabric L./H. Tela cliente L./A. Tissu client L./H.	
			Cat. B	Cat. C/D	Cat. Must	Cat. K	Cat. E	Cat. Plus	Cat. Luxury		
Composition Composición Composition	360CP3N 166 + 2x 35FEPBN 58x55		2.135	2.305	2.470	2.635	3.615	4.445	5.095	2.135	9,91/1,40
Feather Pluma - Plume	360CP3N 166		1.815	1.945	2.070	2.195	2.965	3.605	4.115	1.815	8,25/1,40
Cover Revest. - Housse	C60CE3N 166		605	740	870	1.015	-	-	-	605	8,25/1,40

m³ 1,70 - kg. 60

Central elements

Central

Chaqueuses

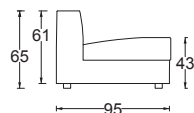
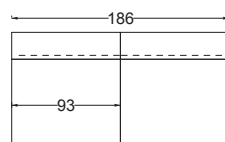
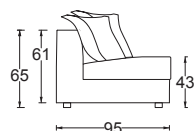
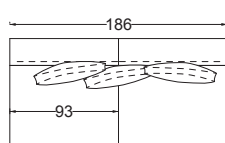

Description Descripción Description	Code Código Code	Side Lado Côté	Fabrics - <i>Telas</i> - Tissu				Leather - <i>Piel</i> - Cuir			C.O.M. fabric L./H. Tela cliente L./A. Tissu client L./H.	
			Cat. B	Cat. C/D	Cat. Must	Cat. K	Cat. E	Cat. Plus	Cat. Luxury		
Composition Composición Composition	360CP3N 186 + 3x 35FEPBN 58x55		2.375	2.565	2.760	2.950	4.065	5.015	5.750	2.375	10,66/1,40
Feather Pluma - Plume	360CP3N 186		1.895	2.025	2.160	2.290	3.090	3.755	4.280	1.895	8,80/1,40
Cover Revest. - Housse	C60CE3N 186		630	760	905	1045	-	-	-	630	8,80/1,40

m³ 1,70 - kg. 73

Central elements

Central
Chauffeuses

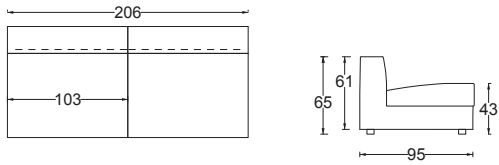
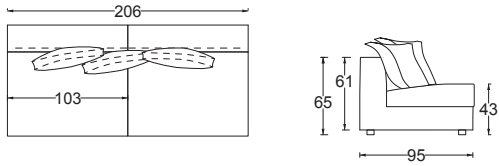

Description Descripción Description	Code Código Code	Side Lado Côté	Fabrics - Telas - Tissu				Leather - Piel - Cuir			C.O.M. fabric L./H. Tela cliente L./A. Tissu client L./H.	
			Cat. B	Cat. C/D	Cat. Must	Cat. K	Cat. E	Cat. Plus	Cat. Luxury		
Composition Composición Composition	360CP3N 206 + 3x 35FEPBN 58x55		2.450	2.645	2.840	3.040	4.175	5.140	5.900	2.450	11,41/1,40
Feather Pluma - Plume	360CP3N 206		1.970	2.105	2.240	2.380	3.200	3.880	4.430	1.970	9,35/1,40
Cover Revest. - Housse	C60CE3N 206		650	790	930	1.080	-	-	-	650	9,35/1,40

m³ 1,85 - kg. 78

Chaise longues

Chaise longues - Chaise Longue

LH / IZDA / G.

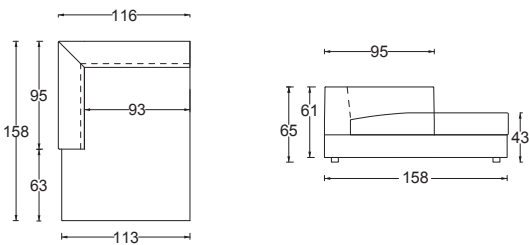
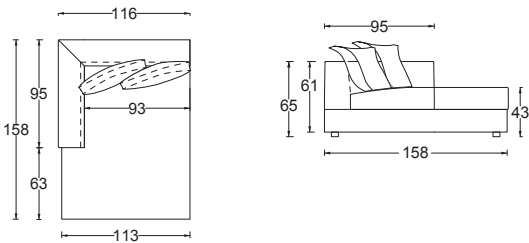

Description Descripción Description	Code Código Code	Side Lado Côté	Fabrics - Telas - Tissu				Leather - Piel - Cuir			C.O.M. fabric L./H. Tela cliente L./A. Tissu client L./H.	
			Cat. B	Cat. C/D	Cat. Must	Cat. K	Cat. E	Cat. Plus	Cat. Luxury		
Composition Composición Composition	360CP5S/R 116 + 2x 35FEPBN 58x55	LH / IZDA / G. RH / DCHA / D.	2.280	2.435	2.590	2.750	3.655	4.430	5.035	2.280	7,76/1,40
Feather Pluma - Plume	360CP5S 116 360CP5R 116	LH / IZDA / G. RH / DCHA / D.	1.960	2.075	2.190	2.310	3.005	3.590	4.055	1.960	6,60/1,40
Cover Revest. - Housse	C60CE5S 116 C60CE5R 116	LH / IZDA / G. RH / DCHA / D.	585	710	840	970	-	-	-	585	6,60/1,40

m³ 2,20 - kg. 90

Dormeuse

Meridienne - Méridienne

LH / IZDA / G.

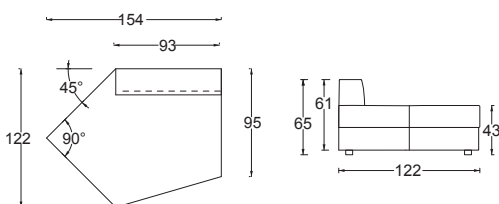
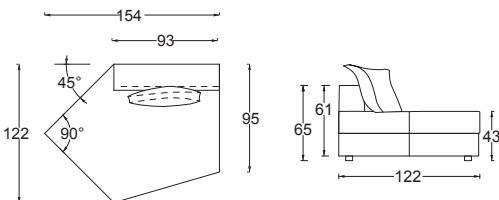

Description Descripción Description	Code Código Code	Side Lado Côté	Fabrics - Telas - Tissu				Leather - Piel - Cuir			C.O.M. fabric L./H. Tela cliente L./A. Tissu client L./H.	
			Cat. B	Cat. C/D	Cat. Must	Cat. K	Cat. E	Cat. Plus	Cat. Luxury		
Composition Composición Composition	360CP7S/R 154 + 35FEPBN 58x55	LH / IZDA / G. RH / DCHA / D.	1.955	2.070	2.190	2.305	3.000	3.585	4.045	1.955	7,04/1,40
Feather Pluma - Plume	360CP7S 154 360CP7R 154	LH / IZDA / G. RH / DCHA / D.	1.795	1.890	1.990	2.085	2.675	3.165	3.555	1.795	5,50/1,40
Cover Revest. - Housse	C60CE7S 154 C60CE7R 154	LH / IZDA / G. RH / DCHA / D.	540	650	765	890	-	-	-	540	5,50/1,40

m³ 1,10 - kg. 45

Footstool

Puff

Pouf

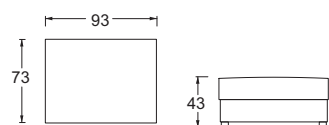

Description Descripción Description	Code Código Code	Side Lado Côté	Fabrics - <i>Telas</i> - Tissu				Leather - <i>Piel</i> - Cuir			C.O.M. fabric L./H. Tela cliente L./A. Tissu client L./H.	
			Cat. B	Cat. C/D	Cat. Must	Cat. K	Cat. E	Cat. Plus	Cat. Luxury		
Feather <i>Pluma</i> - Plume	360CP8N 073		1.120	1.165	1.205	1.250	1.510	1.730	1.905	1.120	1,76/1,40
Cover <i>Revest.</i> - Housse	C60CE8N 073		360	430	495	570	-	-	-	360	1,76/1,40

m³ 1,60 - kg. 60

Footstool

Puff

Pouf

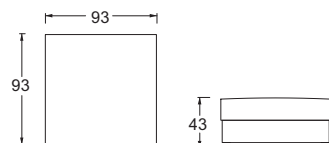

Description Descripción Description	Code Código Code	Side Lado Côté	Fabrics - <i>Telas</i> - Tissu				Leather - <i>Piel</i> - Cuir			C.O.M. fabric L./H. Tela cliente L./A. Tissu client L./H.	
			Cat. B	Cat. C/D	Cat. Must	Cat. K	Cat. E	Cat. Plus	Cat. Luxury		
Feather <i>Pluma</i> - Plume	360CP8N 093		1.265	1.315	1.365	1.415	1.700	1.940	2.130	1.265	2,20/1,40
Cover <i>Revest.</i> - Housse	C60CE8N 093		405	475	550	630	-	-	-	405	2,20/1,40

m³ 1,70 - kg. 65

Back cushion 58x55

Cojines de respaldo

Coussins de dossier

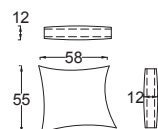

Description Descripción Description	Code Código Code	Side Lado Côté	Fabrics - <i>Telas</i> - Tissu				Leather - <i>Piel</i> - Cuir			C.O.M. fabric L./H. Tela cliente L./A. Tissu client L./H.	
			Cat. B	Cat. C/D	Cat. Must	Cat. K	Cat. E	Cat. Plus	Cat. Luxury		
Pluma <i>Feather</i>	35FEPBN 58x55		160	180	200	220	325	420	490	160	0,70/1,40
Cover <i>Revest.</i> - Housse.	C5FEEBN 58x55		70	85	100	110	-	-	-	70	0,70/1,40

m³ 0,12 - kg. 2,9

Back cushion with rollò 58x55

Cojín de respaldo con rollò

Coussin de dossier avec Rollò

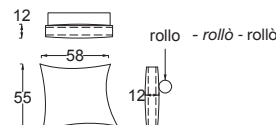

Description Descripción Description	Code Código Code	Side Lado Côté	Fabrics - <i>Telas</i> - Tissu				Leather - <i>Piel</i> - Cuir			C.O.M. fabric L./H. Tela cliente L./A. Tissu client L./H.	
			Cat. B	Cat. C/D	Cat. Must	Cat. K	Cat. E	Cat. Plus	Cat. Luxury		
Feather <i>Pluma</i> - Plume	35FEPBN 058R		190	205	235	260	385	495	585	190	1,20/1,40
Cover <i>Revest.</i> - Housse	C5FEEBN 058R		80	100	120	140	-	-	-	80	1,20/1,40

m³ 0,14 - kg. 3,9

Back cushion 73x51

Cojines de respaldo

Coussins de dossier

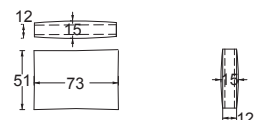

Description Descripción Description	Code Código Code	Side Lado Côté	Fabrics - <i>Telas</i> - Tissu				Leather - <i>Piel</i> - Cuir			C.O.M. fabric L./H. Tela cliente L./A. Tissu client L./H.	
			Cat. B	Cat. C/D	Cat. Must	Cat. K	Cat. E	Cat. Plus	Cat. Luxury		
Feather <i>Pluma</i> - Plume	35FEPBN 073		185	200	220	245	360	465	545	185	0,95/1,40
Cover <i>Revest.</i> - Housse	C5FEECN 073		75	90	105	125	-	-	-	75	0,95/1,40

m³ 0,15 - kg. 3,7

Back cushion with rollò 73x51

Cojín de respaldo con rollò

Coussin de dossier avec Rollò

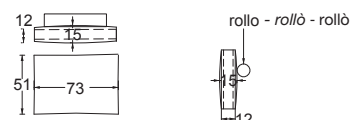

Description Descripción Description	Code Código Code	Side Lado Côté	Fabrics - <i>Telas</i> - Tissu				Leather - <i>Piel</i> - Cuir			C.O.M. fabric L./H. Tela cliente L./A. Tissu client L./H.	
			Cat. B	Cat. C/D	Cat. Must	Cat. K	Cat. E	Cat. Plus	Cat. Luxury		
Feather <i>Pluma</i> - Plume	35FEPBN 073R		215	235	260	290	425	545	640	215	1,45/1,40
Cover <i>Revest.</i> - Housse	C5FEECN 073R		90	110	135	155	-	-	-	90	1,45/1,40

m³ 0,17 - kg. 4,7

Back cushion 83x51

Cojines de respaldo

Coussins de dossier

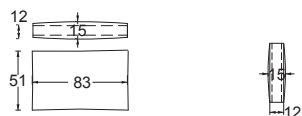

Description Descripción Description	Code Código Code	Side Lado Côté	Fabrics - <i>Telas</i> - Tissu				Leather - <i>Piel</i> - Cuir			C.O.M. fabric L./H. <i>Tela cliente L./A.</i> Tissu client L./H.	
			Cat. B	Cat. C/D	Cat. Must	Cat. K	Cat. E	Cat. Plus	Cat. Luxury		
Feather <i>Pluma - Plume</i>	35FEPCN 083		190	210	240	265	395	505	590	190	0,95/1,40
Cover <i>Revest. - Housse</i>	C5FEECN 083		80	95	120	135	-	-	-	80	0,95/1,40

m³ 0,15 - kg. 4,3

Back cushion with rollò 83x51

Cojín de respaldo con rollò

Coussin de dossier avec Rollò

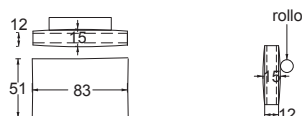

Description Descripción Description	Code Código Code	Side Lado Côté	Fabrics - <i>Telas</i> - Tissu				Leather - <i>Piel</i> - Cuir			C.O.M. fabric L./H. <i>Tela cliente L./A.</i> Tissu client L./H.	
			Cat. B	Cat. C/D	Cat. Must	Cat. K	Cat. E	Cat. Plus	Cat. Luxury		
Feather <i>Pluma - Plume</i>	35FEPCN 083R		220	245	270	300	440	570	670	220	1,45/1,40
Cover <i>Revest. - Housse</i>	C5FEECN 083R		95	120	140	160	-	-	-	95	1,45/1,40

m³ 0,17 - kg. 5,3

Back cushion 93x51

Cojines de respaldo

Coussins de dossier

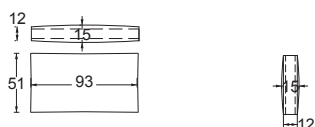

Description Descripción Description	Code Código Code	Side Lado Côté	Fabrics - <i>Telas</i> - Tissu				Leather - <i>Piel</i> - Cuir			C.O.M. fabric L./H. <i>Tela cliente L./A.</i> Tissu client L./H.	
			Cat. B	Cat. C/D	Cat. Must	Cat. K	Cat. E	Cat. Plus	Cat. Luxury		
Feather <i>Pluma - Plume</i>	35FEPCN 093		200	220	250	275	410	525	620	200	1,05/1,40
Cover <i>Revest. - Housse</i>	C5FEECN 093		85	105	130	145	-	-	-	85	1,05/1,40

m³ 0,18 - kg. 4,8

Back cushion with rollò 93x51

Cojín de respaldo con rollò

Coussin de dossier avec Rollò



Description Descripción Description	Code Código Code	Side Lado Côté	Fabrics - <i>Telas</i> - Tissu				Leather - <i>Piel</i> - Cuir			C.O.M. fabric L./H. <i>Tela cliente L./A.</i> Tissu client L./H.	
			Cat. B	Cat. C/D	Cat. Must	Cat. K	Cat. E	Cat. Plus	Cat. Luxury		
Feather <i>Pluma - Plume</i>	35FEPCN 093R		235	255	290	320	475	615	715	235	1,55/1,40
Cover <i>Revest. - Housse</i>	C5FEECN 093R		100	125	145	175	-	-	-	100	1,55/1,40

m³ 0,20 - kg. 5,8

Back cushion 103x51

Cojines de respaldo

Coussins de dossier

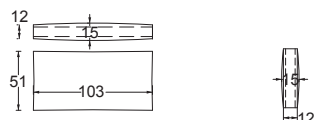

Description Descripción Description	Code Código Code	Side Lado Côté	Fabrics - <i>Telas</i> - Tissu				Leather - <i>Piel</i> - Cuir			C.O.M. fabric L./H. <i>Tela cliente L./A.</i> Tissu client L./H.	
			Cat. B	Cat. C/D	Cat. Must	Cat. K	Cat. E	Cat. Plus	Cat. Luxury		
Feather <i>Pluma - Plume</i>	35FEPCN 103		210	235	260	290	425	545	640	210	1,15/1,40
Cover <i>Revest. - Housse</i>	C5FEECN 103		90	110	135	155	-	-	-	90	1,15/1,40

m³ 0,20 - kg. 5,3

Back cushion with rollò 103x51

Cojín de respaldo con rollò

Coussin de dossier avec Rollò

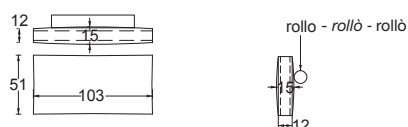

Description Descripción Description	Code Código Code	Side Lado Côté	Fabrics - <i>Telas</i> - Tissu				Leather - <i>Piel</i> - Cuir			C.O.M. fabric L./H. <i>Tela cliente L./A.</i> Tissu client L./H.	
			Cat. B	Cat. C/D	Cat. Must	Cat. K	Cat. E	Cat. Plus	Cat. Luxury		
Feather <i>Pluma - Plume</i>	35FEPCN 103R		250	270	305	340	495	640	750	250	1,65/1,40
Cover <i>Revest. - Housse</i>	C5FEECN 103R		105	130	155	185	-	-	-	105	1,65/1,40

m³ 0,22 - kg. 6,3

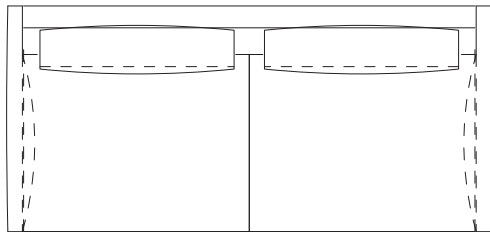
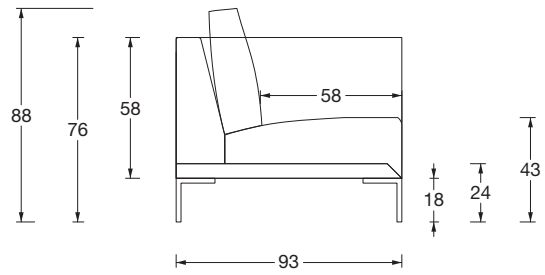
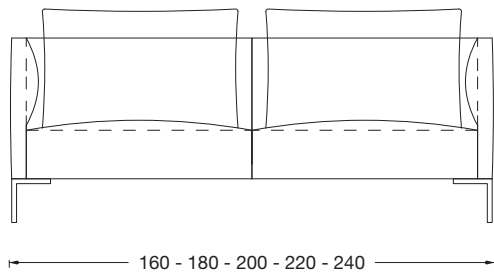

Structure	plywood and solid poplar and fir with vertical and horizontal metal bars crossed elastic belts	<i>Estructura</i>	<i>contrachapado y macizo de álamo y abeto con barras metálicas verticales y horizontales tirantes elásticos cruzados</i>	Structure	contreplaqué en bois et bois massif de sapin et de peuplier avec barres métalliques verticales et horizontales sangles élastiques croisées
Seat	goose feather blend polyurethane ID35 IM and MF D40 pad D40 IF	<i>Asiento</i>	<i>mezcla de pluma de ganso poliuretano ID35 IM y MF D40 torunda D40 IF</i>	Assise	mélange de duvet d'oie polyuréthane ID35 IM et MF D40 tampon D40 IF
Backrest	mix of goose down and silicone fibre	<i>Respaldo</i>	<i>mezcla de pluma de ganso y fibra de silicona</i>	Dossier	mélange de duvet d'oie et de fibre de silicone
Feet	metal feet finish Brown Bronze	<i>Patas</i>	<i>patas metálica acabado Brown Bronze</i>	Pieds	pieds en métal finition Brown Bronze

Completely removable cover

Con funda removible

Housse amovible

Sofas

Sofás
Canapés

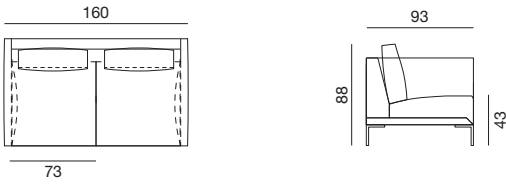

Description Descripción	Code Código	Side Lado	Fabrics - <i>Telas</i> - Tissu				Leather - <i>Piel</i> - Cuir			C.O.M. fabric L./H. Tela cliente L./A. Tissu client L./H.	
			Cat. B	Cat. C/D	Cat. Must	Cat. K	Cat. E	Cat. Plus	Cat. Luxury		
Feather <i>Pluma - Plume</i>	36PCP1N 160		3.260	3.405	3.560	3.715	4.630	5.390	6.005	3.260	8,91/1,40
Cover <i>Revest. - Housse.</i>	C6PCE1N 160		880	1.040	1.200	1.360	2.325	3.125	3.770	880	8,91/1,40

Feet in Black Nickel finish
Patas en acabado Black Nickel
Pieds en finition Black Nickel

+ 145

m³ 1,40 - kg. 76

Sofas

Sofás
Canapés

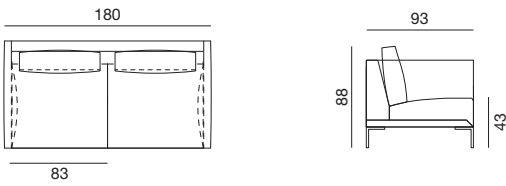

Description Descripción	Code Código	Side Lado	Fabrics - <i>Telas</i> - Tissu				Leather - <i>Piel</i> - Cuir			C.O.M. fabric L./H. Tela cliente L./A. Tissu client L./H.	
			Cat. B	Cat. C/D	Cat. Must	Cat. K	Cat. E	Cat. Plus	Cat. Luxury		
Feather <i>Pluma - Plume</i>	36PCP1N 180		3.445	3.610	3.780	3.950	4.970	5.810	6.490	3.445	9,79/1,40
Cover <i>Revest. - Housse</i>	C6PCE1N 180		945	1.120	1.300	1.475	2.545	3.435	4.150	945	9,79/1,40

Feet in Black Nickel finish
Patas en acabado Black Nickel
Pieds en finition Black Nickel

+ 145

m³ 1,57 - kg. 82

Sofas

Sofás
Canapés

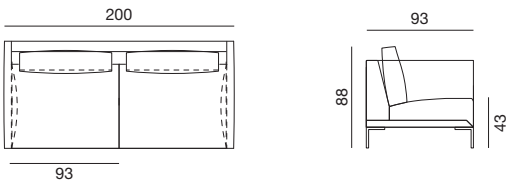

Description Descripción	Code Código	Side Lado	Fabrics - <i>Telas</i> - Tissu				Leather - <i>Piel</i> - Cuir			C.O.M. fabric L./H. Tela cliente L./A. Tissu client L./H.	
			Cat. B	Cat. C/D	Cat. Must	Cat. K	Cat. E	Cat. Plus	Cat. Luxury		
Feather <i>Pluma - Plume</i>	36PCP1N 200		3.620	3.810	3.995	4.180	5.300	6.230	6.970	3.620	10,12/1,40
Cover <i>Revest. - Housse</i>	C6PCE1N 200		1.005	1.200	1.395	1.590	2.765	3.740	4.530	1.005	10,12/1,40

Feet in Black Nickel finish
Patas en acabado Black Nickel
Pieds en finition Black Nickel

+ 145

m³ 1,75 - kg. 88

Sofas

Sofás
Canapés

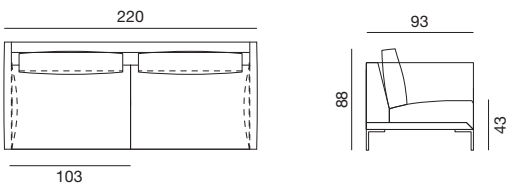

Description Descripción	Code Código	Side Lado	Fabrics - <i>Telas</i> - Tissu				Leather - <i>Piel</i> - Cuir			C.O.M. fabric L./H. Tela cliente L./A. Tissu client L./H.	
			Cat. B	Cat. C/D	Cat. Must	Cat. K	Cat. E	Cat. Plus	Cat. Luxury		
Feather <i>Pluma - Plume</i>	36PCP1N 220	LH/IZDA/G. RH/DCHA/D.	3.815	4.010	4.215	4.420	5.635	6.650	7.460	3.815	10,45/1,40
Cover <i>Revest. - Housse</i>	C6PCE1N 220	LH/IZDA/G. RH/DCHA/D.	1.065	1.280	1.495	1.705	2.985	4.050	4.910	1.065	10,45/1,40

Feet in Black Nickel finish
Patas en acabado Black Nickel
Pieds en finition Black Nickel

+ 145

m³ 1,92 - kg. 94

Sofas

Sofás
Canapés

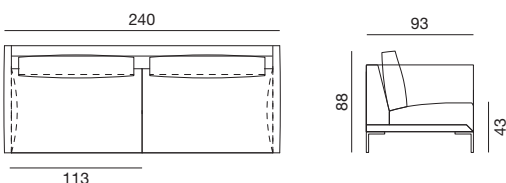

Description Descripción	Code Código	Side Lado	Fabrics - <i>Telas</i> - Tissu				Leather - <i>Piel</i> - Cuir			C.O.M. fabric L./H. Tela cliente L./A. Tissu client L./H.	
			Cat. B	Cat. C/D	Cat. Must	Cat. K	Cat. E	Cat. Plus	Cat. Luxury		
Feather <i>Pluma - Plume</i>	36PCP1N 240	LH/IZDA/G. RH/DCHA/D.	4.035	4.255	4.475	4.695	6.010	7.110	7.985	4.035	10,89/1,40
Cover <i>Revest. - Housse</i>	C6PCE1N 240	LH/IZDA/G. RH/DCHA/D.	1.125	1.355	1.585	1.815	3.205	4.360	5.280	1.125	10,89/1,40

Feet in Black Nickel finish
Patas en acabado Black Nickel
Pieds en finition Black Nickel

+ 145

m³ 2,10 - kg. 100

Side element

Lateral

Éléments latéraux

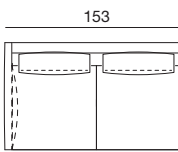

73

LH / IZDA / G.

Description Descripción Description	Code Código Code	Side Lado Côté	Fabrics - <i>Telas</i> - Tissu				Leather - <i>Piel</i> - Cuir			C.O.M. fabric L./H. <i>Tela cliente L./A.</i> Tissu client L./H.	
			Cat. B	Cat. C/D	Cat. Must	Cat. K	Cat. E	Cat. Plus	Cat. Luxury		
Feather <i>Pluma</i> - Plume	36PCP2S 153 36PCP2R 153	LH / IZDA / G. RH / DCHA / D.	3.035	3.175	3.315	3.450	4.290	4.990	5.550	3.035	7,92/1,40
Cover <i>Revest.</i> - Housse	C6PCE2S 153 C6PCE2R 153	LH / IZDA / G. RH / DCHA / D.	810	955	1.100	1.245	2.115	2.840	3.425	810	7,92/1,40

Feet in Black Nickel finish
Patas en acabado Black Nickel
Pieds en finition Black Nickel

+ 145

m³ 1,34 - kg. 71

Side element

Lateral

Éléments latéraux

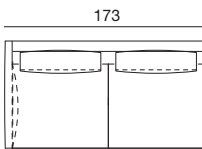

83

LH / IZDA / G.

Description Descripción Description	Code Código Code	Side Lado Côté	Fabrics - <i>Telas</i> - Tissu				Leather - <i>Piel</i> - Cuir			C.O.M. fabric L./H. <i>Tela cliente L./A.</i> Tissu client L./H.	
			Cat. B	Cat. C/D	Cat. Must	Cat. K	Cat. E	Cat. Plus	Cat. Luxury		
Feather <i>Pluma</i> - Plume	36PCP2S 173 36PCP2R 173	LH / IZDA / G. RH / DCHA / D.	3.225	3.380	3.540	3.695	4.635	5.420	6.045	3.225	8,91/1,40
Cover <i>Revest.</i> - Housse	C6PCE2S 173 C6PCE2R 173	LH / IZDA / G. RH / DCHA / D.	870	1.035	1.195	1.360	2.335	3.150	3.805	870	8,91/1,40

Feet in Black Nickel finish
Patas en acabado Black Nickel
Pieds en finition Black Nickel

+ 145

m³ 1,51 - kg. 77

Side element

Lateral

Éléments latéraux

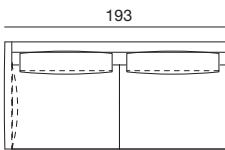

93

LH / IZDA / G.

Description Descripción Description	Code Código Code	Side Lado Côté	Fabrics - <i>Telas</i> - Tissu				Leather - <i>Piel</i> - Cuir			C.O.M. fabric L./H. <i>Tela cliente L./A.</i> Tissu client L./H.	
			Cat. B	Cat. C/D	Cat. Must	Cat. K	Cat. E	Cat. Plus	Cat. Luxury		
Feather <i>Pluma</i> - Plume	36PCP2S 193 36PCP2R 193	LH / IZDA / G. RH / DCHA / D.	3.405	3.575	3.755	3.925	4.970	5.840	6.530	3.405	9,02/1,40
Cover <i>Revest.</i> - Housse	C6PCE2S 193 C6PCE2R 193	LH / IZDA / G. RH / DCHA / D.	930	1.115	1.295	1.475	2.555	3.455	4.180	930	9,02/1,40

Feet in Black Nickel finish
Patas en acabado Black Nickel
Pieds en finition Black Nickel

+ 145

m³ 1,68 - kg. 83

Side element

Lateral

Éléments latéraux

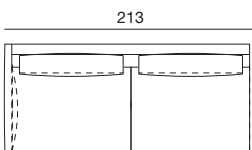

103

LH / IZDA / G.

Description Descripción Description	Code Código Code	Side Lado Côté	Fabrics - <i>Telas</i> - Tissu				Leather - <i>Piel</i> - Cuir			C.O.M. fabric L./H. <i>Tela cliente L./A.</i> Tissu client L./H.	
			Cat. B	Cat. C/D	Cat. Must	Cat. K	Cat. E	Cat. Plus	Cat. Luxury		
Feather <i>Pluma</i> - Plume	36PCP2S 213 36PCP2R 213	LH / IZDA / G. RH / DCHA / D.	3.600	3.785	3.980	4.170	5.315	6.265	7.025	3.600	9,35/1,40
Cover <i>Revest.</i> - Housse	C6PCE2S 213 C6PCE2R 213	LH / IZDA / G. RH / DCHA / D.	990	1.190	1.390	1.585	2.775	3.765	4.555	990	9,35/1,40

Feet in Black Nickel finish
Patas en acabado Black Nickel
Pieds en finition Black Nickel

+ 145

m³ 1,86 - kg. 89

Corner

Ángulo

Élément d'angle

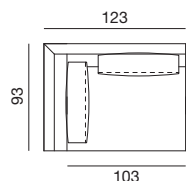

LH / IZDA / G.

Description Descripción Description	Code Código Code	Side Lado Côté	Fabrics - <i>Telas</i> - Tissu				Leather - <i>Piel</i> - Cuir			C.O.M. fabric L./H. <i>Tela cliente L./A.</i> Tissu client L./H.	
			Cat. B	Cat. C/D	Cat. Must	Cat. K	Cat. E	Cat. Plus	Cat. Luxury		
Feather <i>Pluma</i> - Plume	36PCP4S 103 36PCP4R 103	LH / IZDA / G. RH / DCHA / D.	1.640	1.780	1.920	2.060	2.900	3.600	4.155	1.640	8,91/1,40
Cover <i>Revest.</i> - Housse	C6PCE4S 103 C6PCE4R 103	LH / IZDA / G. RH / DCHA / D.	295	440	585	730	1.605	2.330	2.905	295	8,91/1,40

Feet in Black Nickel finish
Patas en acabado Black Nickel
Pieds en finition Black Nickel

+ 145

m³ 0,90 - kg. 58

Side corner

Terminale ángulo - Élément d'angle

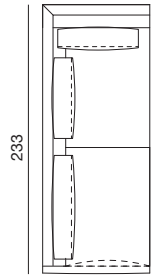

LH / IZDA / G.

Description Descripción Description	Code Código Code	Side Lado Côté	Fabrics - <i>Telas</i> - Tissu				Leather - <i>Piel</i> - Cuir			C.O.M. fabric L./H. Tela cliente L./A. Tissu client L./H.
			Cat. B	Cat. C/D	Cat. Must	Cat. K	Cat. E	Cat. Plus	Cat. Luxury	
Feather <i>Pluma</i> - Plume	36PCP4S 233 36PCP4R 233	LH/IZDA/G. RH/DCHA/D.	3.755	3.995	4.230	4.475	5.920	7.120	8.080	3.755 11,00/1,40
Cover <i>Revest.</i> - Housse	C6PCE4S 233 C6PCE4R 233	LH/IZDA/G. RH/DCHA/D.	1.210	1.485	1.760	2.035	3.685	5.060	6.160	1.210 11,00/1,40

Feet in Black Nickel finish
Patas en acabado Black Nickel
Pieds en finition Black Nickel **+ 145**

m³ 2,03 - kg. 100

Chaise longues

Chaise longues - Chaise Longue

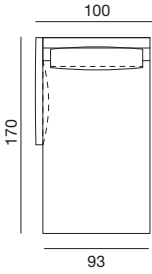

LH / IZDA / G.

Description Descripción Description	Code Código Code	Side Lado Côté	Fabrics - <i>Telas</i> - Tissu				Leather - <i>Piel</i> - Cuir			C.O.M. fabric L./H. Tela cliente L./A. Tissu client L./H.
			Cat. B	Cat. C/D	Cat. Must	Cat. K	Cat. E	Cat. Plus	Cat. Luxury	
Feather <i>Pluma</i> - Plume	36PCP5S 100 36PCP5R 100	LH/IZDA/G. RH/DCHA/D.	2.280	2.420	2.565	2.710	3.555	4.265	4.830	2.280 7,70/1,40
Cover <i>Revest.</i> - Housse	C6PCE5S 100 C6PCE5R 100	LH/IZDA/G. RH/DCHA/D.	300	450	595	740	1.625	2.360	2.950	300 7,70/1,40

Feet in Black Nickel finish
Patas en acabado Black Nickel
Pieds en finition Black Nickel **+ 145**

m³ 1,62 - kg. 58

Footstool

Puff
Pouf

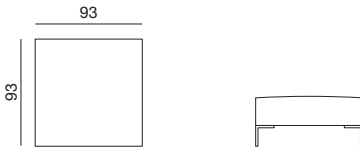

LH / IZDA / G.

Description Descripción Description	Code Código Code	Side Lado Côté	Fabrics - <i>Telas</i> - Tissu				Leather - <i>Piel</i> - Cuir			C.O.M. fabric L./H. Tela cliente L./A. Tissu client L./H.
			Cat. B	Cat. C/D	Cat. Must	Cat. K	Cat. E	Cat. Plus	Cat. Luxury	
Feather <i>Pluma</i> - Plume	36PCP8N 093		1.165	1.200	1.245	1.290	1.540	1.755	1.920	1.165 2,42/1,40
Cover <i>Revest.</i> - Housse	C6PCE8N 093		250	295	340	380	645	865	1.040	250 2,42/1,40

Feet in Black Nickel finish
Patas en acabado Black Nickel
Pieds en finition Black Nickel **+ 145**

m³ 0,90 - kg. 20



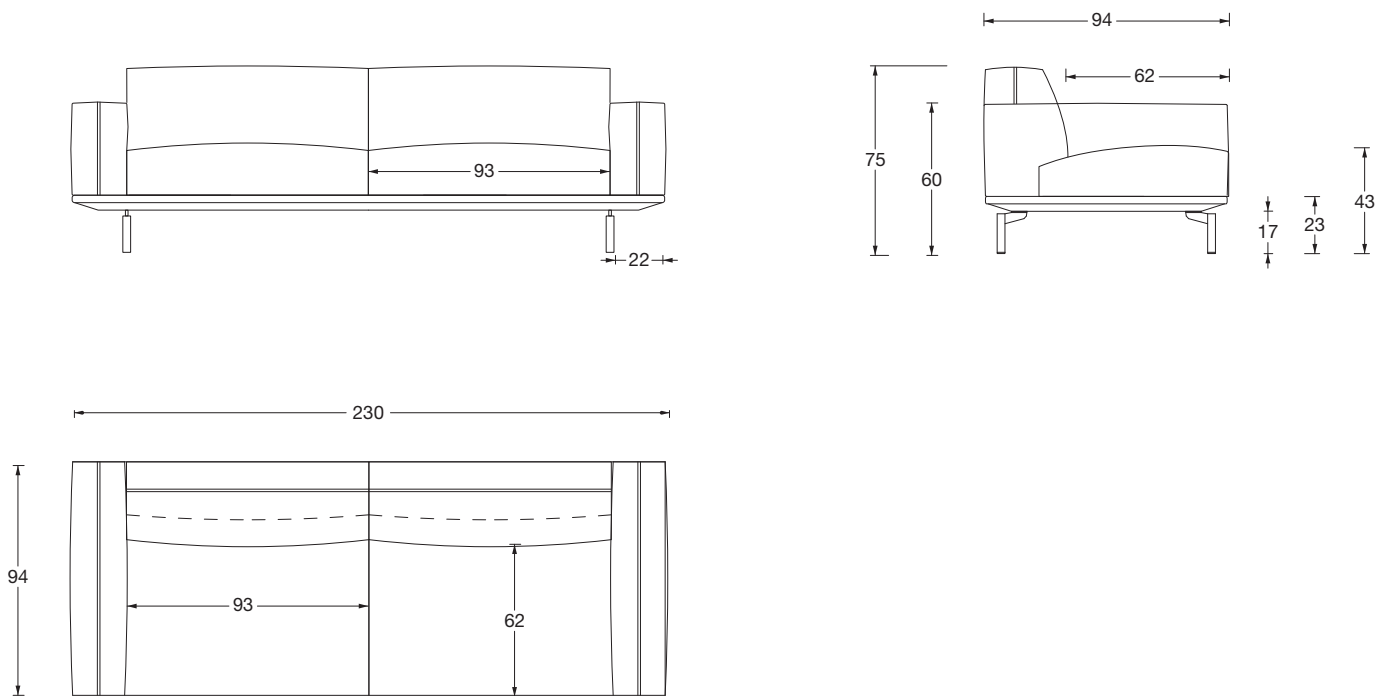

Base seat

plywood and solid poplar and fir
elastic belts 6/8 cm cross weft
pressed polyester fiber

Seat

goose feather blend
polyurethane D35 IM
memory foam D40
100% cotton fabric

Backrest

wood fibre
polyurethane D21 IM
polyurethane D25 IM
pressed polyester fiber
memory foam D40

Armrest

wood fibre
polyurethane D40 IM
polyurethane D30 IP

Feet

metal feet painted matte black or
Brown Bronze

Base asiento

madera contrachapada y maciza de álamo y
abeto tirantes elásticos cruzados de 6 y 8 cm
fibra de poliéster prensada

Asiento

mezcla de pluma de ganso
poliuretano D35 IM
espuma memory D40
tela 100% algodón

Respaldo

fibra de madera
poliuretano D21 IM
poliuretano D25 IM
fibra de poliéster prensada
espuma memory D40

Brazos

fibra de madera
poliuretano D40 IM
poliuretano IP D30 Pie

Patas

patas de metal pintado negro mate o
Brown Bronze

Base assise

contreplaqué en bois et bois massif de sapin
et de peuplier sangles élastiques 6 et 8 cm
croisées fibre de polyester pressée

Assise

mélange de duvet d'oie
polyuréthane D35 IM
mousse memoire D40
tissu 100% coton

Dossier

fibre de bois
polyuréthane D21 IM
polyuréthane D25 IM
fibre de polyester pressée
mousse memoire D40

Accoudoir

fibre de bois
polyuréthane D40 IPP
polyuréthane D30 IP

Pieds

pieds en metal peint en noir mat ou
Brown Bronze

Completely removable cover

Con funda removible

Housse amovible

Street finishing

Acabado Street - Finition Street



Available colours

Colores disponibles - Couleurs disponibles

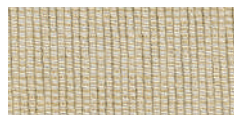

Sabbia NC7149



Tortora NC7051

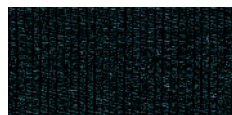

Antracite NC7056

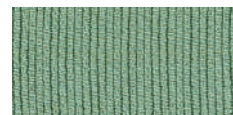

Salvia NC7124



Verde bosco NC7132

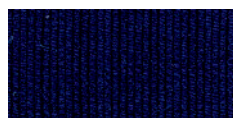

Blu oceano NC7115



Bordeaux NC7088



Testa di moro NC7101

Grosgrain ribbon
comp. 60% cotton
40% acrylic
Cinta de grosgrain comp.
60% algodón 40% acrílico
Ruban gros-grain
Comp. 60% coton
40% acrylique

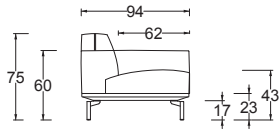
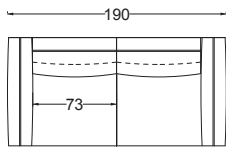
SofasSofás
Canapés

Description Descripción Description	Code Código Code	Side Lado Côté	Fabrics - <i>Telas</i> - Tissu				Leather - <i>Piel</i> - Cuir			C.O.M. fabric L./H. <i>Tela cliente L./A.</i> Tissu client L./H.	
			Cat. B	Cat. C/D	Cat. Must	Cat. K	Cat. E	Cat. Plus	Cat. Luxury		
Feather <i>Pluma</i> - Plume	36VCP1N 190		3.055	3.200	3.335	3.475	4.310	5.005	5.565	3.055	8,00/1,40
Cover <i>Revest.</i> - Housse	C6VCE1N 190		750	895	1.030	1.170	-	-	-	750	8,00/1,40

m² 1,70 - kg. 68

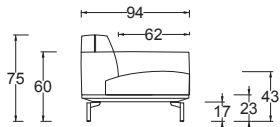
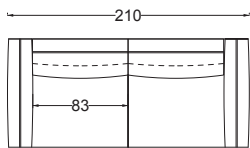
SofasSofás
Canapés

Description Descripción Description	Code Código Code	Side Lado Côté	Fabrics - <i>Telas</i> - Tissu				Leather - <i>Piel</i> - Cuir			C.O.M. fabric L./H. <i>Tela cliente L./A.</i> Tissu client L./H.	
			Cat. B	Cat. C/D	Cat. Must	Cat. K	Cat. E	Cat. Plus	Cat. Luxury		
Feather <i>Pluma</i> - Plume	36VCP1N 210		3.230	3.380	3.530	3.680	4.580	5.325	5.930	3.230	9,00/1,40
Cover <i>Revest.</i> - Housse	C6VCE1N 210		795	945	1.090	1.240	-	-	-	795	9,00/1,40

m² 1,80 - kg. 85

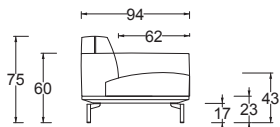
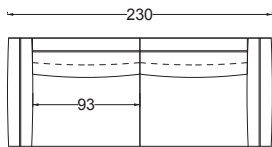
SofasSofás
Canapés

Description Descripción Description	Code Código Code	Side Lado Côté	Fabrics - <i>Telas</i> - Tissu				Leather - <i>Piel</i> - Cuir			C.O.M. fabric L./H. <i>Tela cliente L./A.</i> Tissu client L./H.	
			Cat. B	Cat. C/D	Cat. Must	Cat. K	Cat. E	Cat. Plus	Cat. Luxury		
Feather <i>Pluma</i> - Plume	36VCP1N 230		3.370	3.520	3.680	3.835	4.780	5.565	6.195	3.370	10,00/1,40
Cover <i>Revest.</i> - Housse	C6VCE1N 230		825	980	1.135	1.290	-	-	-	825	10,00/1,40

m² 2,00 - kg. 92

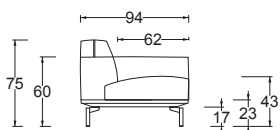
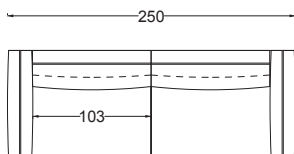
SofasSofás
Canapés

Description Descripción Description	Code Código Code	Side Lado Côté	Fabrics - <i>Telas</i> - Tissu				Leather - <i>Piel</i> - Cuir			C.O.M. fabric L./H. <i>Tela cliente L./A.</i> Tissu client L./H.	
			Cat. B	Cat. C/D	Cat. Must	Cat. K	Cat. E	Cat. Plus	Cat. Luxury		
Feather <i>Pluma</i> - Plume	36VCP1N 250		3.570	3.740	3.915	4.085	5.110	5.965	6.650	3.570	11,00/1,40
Cover <i>Revest.</i> - Housse	C6VCE1N 250		875	1.040	1.205	1.370	-	-	-	875	11,00/1,40

m² 2,20 - kg. 100

Side element

Lateral

Éléments latéraux

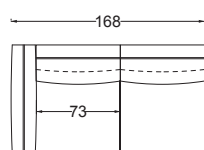

Description Descripción Description	Code Código Code	Side Lado Côté	Fabrics - <i>Telas</i> - Tissu				Leather - <i>Piel</i> - Cuir			C.O.M. fabric L./H. Tela cliente L./A. Tissu client L./H.	
			Cat. B	Cat. C/D	Cat. Must	Cat. K	Cat. E	Cat. Plus	Cat. Luxury		
Feather <i>Pluma</i> - Plume	36VCP2S 168 36VCP2R 168	LH / IZDA / G. RH / DCHA / D.	2.710	2.830	2.955	3.080	3.820	4.435	4.925	2.710	7,00/1,40
Cover <i>Revest.</i> - Housse	C6VCE2S 168 C6VCE2R 168	LH / IZDA / G. RH / DCHA / D.	670	790	915	1.035	-	-	-	670	7,00/1,40

m³ 1,50 - kg. 67

Side element

Lateral

Éléments latéraux

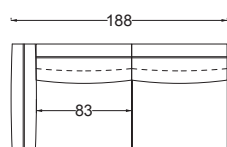

Description Descripción Description	Code Código Code	Side Lado Côté	Fabrics - <i>Telas</i> - Tissu				Leather - <i>Piel</i> - Cuir			C.O.M. fabric L./H. Tela cliente L./A. Tissu client L./H.	
			Cat. B	Cat. C/D	Cat. Must	Cat. K	Cat. E	Cat. Plus	Cat. Luxury		
Feather <i>Pluma</i> - Plume	36VCP2S 188 36VCP2R 188	LH / IZDA / G. RH / DCHA / D.	2.940	3.075	3.210	3.345	4.145	4.815	5.350	2.940	7,80/1,40
Cover <i>Revest.</i> - Housse	C6VCE2S 188 C6VCE2R 188	LH / IZDA / G. RH / DCHA / D.	725	855	990	1.125	-	-	-	725	7,80/1,40

LH / IZDA / G.

m³ 1,60 - kg. 75

Side element

Lateral

Éléments latéraux

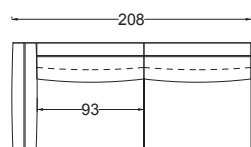

Description Descripción Description	Code Código Code	Side Lado Côté	Fabrics - <i>Telas</i> - Tissu				Leather - <i>Piel</i> - Cuir			C.O.M. fabric L./H. Tela cliente L./A. Tissu client L./H.	
			Cat. B	Cat. C/D	Cat. Must	Cat. K	Cat. E	Cat. Plus	Cat. Luxury		
Feather <i>Pluma</i> - Plume	36VCP2S 208 36VCP2R 208	LH / IZDA / G. RH / DCHA / D.	3.145	3.290	3.435	3.570	4.430	5.140	5.710	3.145	8,50/1,40
Cover <i>Revest.</i> - Housse	C6VCE2S 208 C6VCE2R 208	LH / IZDA / G. RH / DCHA / D.	770	915	1.060	1.200	-	-	-	770	8,50/1,40

LH / IZDA / G.

m³ 1,85 - kg. 82

Corner

Ángulo

Élément d'angle

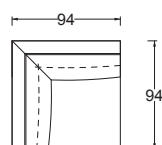

Description Descripción Description	Code Código Code	Side Lado Côté	Fabrics - <i>Telas</i> - Tissu				Leather - <i>Piel</i> - Cuir			C.O.M. fabric L./H. Tela cliente L./A. Tissu client L./H.	
			Cat. B	Cat. C/D	Cat. Must	Cat. K	Cat. E	Cat. Plus	Cat. Luxury		
Feather <i>Pluma</i> - Plume	36VCP4N 094	LH / IZDA / G. RH / DCHA / D.	1.685	1.760	1.840	1.920	2.390	2.785	3.100	1.685	5,50/1,40
Cover <i>Revest.</i> - Housse	C6VCE4N 094	LH / IZDA / G. RH / DCHA / D.	415	490	570	645	-	-	-	415	5,50/1,40

m³ 0,90 - kg. 60

Chaise longues

Chaise longues - Chaise Longue

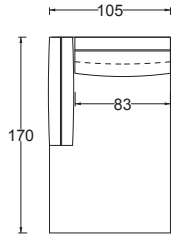

LH / IZDA / G.

Description Descripción Description	Code Código Code	Side Lado Côté	Fabrics - <i>Telas</i> - Tissu				Leather - <i>Piel</i> - Cuir			C.O.M. fabric L./H. Tela cliente L./A. Tissu client L./H.
			Cat. B	Cat. C/D	Cat. Must	Cat. K	Cat. E	Cat. Plus	Cat. Luxury	
Feather Pluma - Plume	36VCP5S 105 36VCP5R 105	LH / IZDA / G. RH / DCHA / D.	2.610	2.715	2.820	2.930	3.570	4.105	4.530	2.610 6,50/1,40
Cover Revest. - Housse	C6VCE5S 105 C6VCE5R 105	LH / IZDA / G. RH / DCHA / D.	640	755	870	985	-	-	-	640 6,50/1,40

m³ 1,62 - kg. 70

Footstool

Puff

Pouf

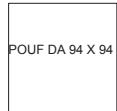

Description Descripción Description	Code Código Code	Side Lado Côté	Fabrics - <i>Telas</i> - Tissu				Leather - <i>Piel</i> - Cuir			C.O.M. fabric L./H. Tela cliente L./A. Tissu client L./H.
			Cat. B	Cat. C/D	Cat. Must	Cat. K	Cat. E	Cat. Plus	Cat. Luxury	
Feather Pluma - Plume	36VCP8N 094		1.265	1.300	1.340	1.370	1.585	1.760	1.910	1.265 2,50/1,40
Cover Revest. - Housse	C6VCE8N 094		315	365	415	465	-	-	-	315 2,50/1,40

m³ 0,40 - kg. 20



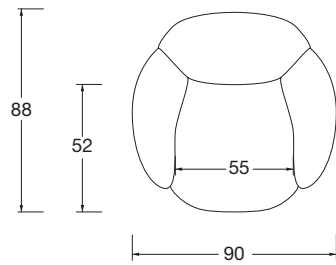
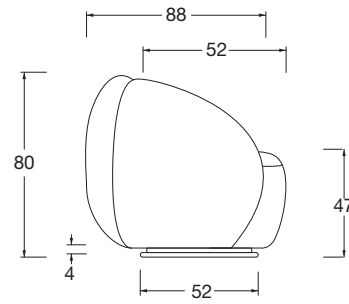
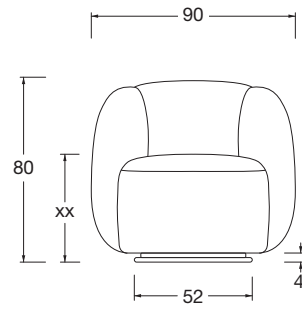

Structure

plywood panels and poplar or pine wood wood fibreboard
elastic belts 6 cm cross weft
polyurethane foam 35P
polyurethane foame PF 30 Elast
280 gr polyester fibre covered with cotton fabric

Feet

feet in black ABS h. 4 cm optional swivel base

Estructura

madera contrachapada y maciza de álamo y abeto
fibra de madera
tirantes elásticos cruzados de 6 cm
espuma de poliuretano 35P
espuma de poliuretano PF 30 elast
fibra de poliéster de 280 gr/m² junto con tejido 100% algodón

Patatas

patas negras ABS h. 4 cm opcional base giratoria

Structure

contreplaqué en bois et bois massif de sapin et de peuplier
sangles élastiques 6 et 8 cm croisées
polyuréthane expansé 35P
polyuréthane expansé PF 30 elast
fibre de polyester 280 gr. couplée à un tissu de coton

Pieds

pieds ABS NOIR h. 4 cm en option base pivotante

Completely removable cover (no leather)

Funda completamente desfundable (no en piel)

Housse amovible (pas de cuir)

Armchair

Sillón
Fauteuil

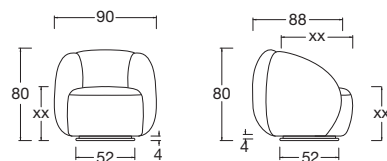

Description Descripción Description	Code Código Code	Side Lado Côté	Fabrics - Telas - Tissu				Leather - Piel - Cuir			C.O.M. fabric L./H. Tela cliente L./A. Tissu client L./H.	
			Cat. B	Cat. C/D	Cat. Must	Cat. K	Cat. E	Cat. Plus	Cat. Luxury		
Foam Espuma - Mousse	37D With swivel base Con base giratoria Avec base pivotante		2.050	2.130	2.215	2.295	2.795	3.215	3.550	2.050	3,00/1,40
Cover Revest. - Housse	C7D		845	930	1.020	1.110	-	-	-	845	3,00/1,40

m³ 0,5 - kg. 39

Footstool

Puff
Pouf



Description Descripción Description	Code Código Code	Side Lado Côté	Fabrics - Telas - Tissu				Leather - Piel - Cuir			C.O.M. fabric L./H. Tela cliente L./A. Tissu client L./H.	
			Cat. B	Cat. C/D	Cat. Must	Cat. K	Cat. E	Cat. Plus	Cat. Luxury		
Foam Espuma - Mousse	37DP		1.020	1.075	1.125	1.180	1.495	1.750	1.960	1.020	3,00/1,40
Cover Revest. - Housse.			475	530	585	640	-	-	-	475	3,00/1,40

m³ 0,5 - kg. 39

OTTO coffee table

OTTO mesita
OTTO petit table

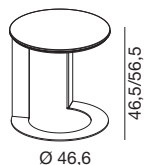

Price with top - Precio con top - Prix avec top

Code Código - Code	H.xØ	Nero Opaco	Verniciato Opaco	Noce Canaletto
420X44H45	H.45 Ø55	435	455	495
420X44H55	H.55 Ø55	460	485	525

	Nero opaco		Canapa		Noce canaletto
			Visone		
			Juta		

Structure finishing
Acabado ESTRUCTURA - Finition STRUCTURE

	Brown Bronze		Grafite
--	--------------	--	---------

ORION TONDO coffee table

ORION TONDO mesita
ORION TONDO petit table

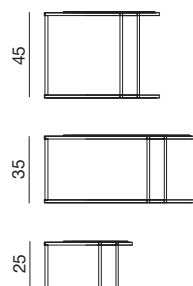

Price with top - Precio con top - Prix avec top

Code Código - Code	H.xØ	Nero Opaco	Verniciato Opaco	Noce Canaletto
42NX77H45	H.45 Ø60	570	590	640
42NXCCH35	H.35 Ø80	725	760	820
42NX44H25	H.25 Ø45	385	405	415

	Nero opaco		Canapa		Noce canaletto
			Visone		
			Juta		

Structure finishing
Acabado ESTRUCTURA - Finition STRUCTURE

	Nero Opaco		Brown Bronze
--	------------	--	--------------

ORION TONDO footstool

ORION TONDO puf
ORION TONDO pouf

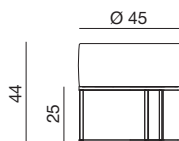

Description Descripción Description	Code Código Code	Side Lado Côté	Fabrics - Telas - Tissu				Leather - Piel - Cuir			C.O.M. fabric L./H. Tela cliente L./A. Tissu client L./H.	
			Cat. B	Cat. C/D	Cat. Must	Cat. K	Cat. E	Cat. Plus	Cat. Luxury		
H.44	42NX44H42	H.44 Ø45	560	605	620	630	705	770	820	560	1,20/1,40

Structure finishing
Acabado ESTRUCTURA - Finition STRUCTURE

	Nero Opaco		Brown Bronze
--	------------	--	--------------



Check the 2023 price list

Consultar la lista de precios 2023

Consultez le liste de prix 2023

Kit Box for storage bed (made up of bed base, mechanism and bottom panels)

Kit Box para cama contenedor (hecho de somier, mecanismo, paneles de contenedor de cama)

Kit box pour lit avec coffre (composé d'un sommier, mécanismes et panneaux inférieurs)



ORTOPEDIC PLUS with metal frame

ORTOPEDIC PLUS con estructura metálica

ORTOPEDIC PLUS avec structure en metal

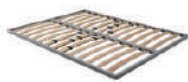

The "Ortopedic Plus" kit box is standard. For the bed with kit box One, Comfort, Ergo Plus, add the following prices to bed without bed base H 22, 25, 28 cm.

El kit box "Ortopedic Plus" es estándar. Para la cama con kit box One, Comfort, Ergo Plus, sumar los siguientes precios a la cama sin somier H 22, 25, 28 cm. Le coffre avec somier à lattes "Ortopedic Plus" est standard. Pour le coffre avec somier One, Comfort, Ergo Plus, veuillez ajouter les prix suivants au prix du lit sans somier H 22, 25, 28 cm.

Bed bases Somieres Sommier	Code Código Code	190 3	200 5	210 7	Two-piece bed base Somier en dos piezas Sommier en deux pièces	m ³	kg
200	KBT80C20.	1.285	1.290	1.335	+175	0,43	40
193	KBT80C19K.	-	1.290	-	+175	0,43	43
180	KBT80C18.	990	990	1.035	+175	0,29	45
170	KBT80C17.	990	990	1.035	+175	0,28	58
160	KBT80C16.	870	870	920	+175	0,27	60
153	KBT80C15Q.	-	870	-	+175	0,27	69
140	KBT80C14.	870	870	920	+175	0,24	69
120	KBT80C12.	720	710	735	-	0,22	70
100	KBT80C10.	720	710	735	-	0,19	74
90	KBT80C09.	595	595	640	-	0,18	87
80	KBT80C08.	595	595	640	-	0,17	87

COMFORT with metal frame

COMFORT con estructura metálica

COMFORT avec structure en metal



With anatomical supports and weight regulators.

Soportes anatómicos y reguladores de peso. Supports anatomiques et régulateurs de poids.

Bed bases Somieres Sommier	Code Código Code	190 3	200 5	210 7	Two-piece bed base Somier en dos piezas Sommier en deux pièces	m ³	kg
200	KBT80220.	-	1.860	-	+175	0,30	88
193	KBT80219K.	-	1.860	-	+175	0,30	88
180	KBT80218.	-	1.210	-	+175	0,29	86
170	KBT80217.	-	1.450	-	+175	0,28	81
160	KBT80216.	-	1.095	-	+175	0,27	79
153	KBT80215Q.	-	1.095	-	+175	0,27	79
140	KBT80214.	-	1.300	-	+175	0,24	70
120	KBT80212.	-	1.045	-	-	0,22	62
100	KBT80210.	-	1.015	-	-	0,30	50
90	KBT80209.	-	900	-	-	0,24	45
80	KBT80208.	-	890	-	-	0,17	43

ONE with metal frame

ONE con estructura metálica

ONE avec structure en metal

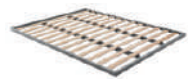

Bed bases Somieres Sommier	Code Código Code	190 3	200 5	210 7	Two-piece bed base Somier en dos piezas Sommier en deux pièces	m ³	kg
160	KBT80516.	-	1.025	-	-	0,46	71
180	KBT80518.	-	1.140	-	-	0,50	80

ERGO PLUS with metal frame

ERGO PLUS con estructura metálica

ERGO PLUS avec structure en metal

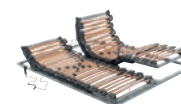

Bed base with electrically adjustable head/foot sections and wooden free with anatomical supports and weight regulators.

Somier con mecanismo de elevación del cabecero/piecerro motorizado con soportes anatómicos y reguladores de peso.

Sommier électrique avec tête et pieds relevables, avec support anatomiques et régulateurs de poids.

Bed bases Somieres Sommier	Code Código Code	190 3	200 5	210 7	Two-piece bed base Somier en dos piezas Sommier en deux pièces	m ³	kg
160	KBT80E16.	-	4.700	-	+175	0,40	73



Wireless remote controller

Control remoto inalámbrico
Télécommande sans fil

Pcs.
+ 215 Pieza.
Pièce



Double cable, to control two motors with a push-button panel

Cable doble, para controlar dos motores con un panel de botones.
Double câble pour contrôler deux moteurs avec un clavier

+ 165

Extra charge - Recargos - Suppléments

Kit Box double Moving available for bed bases: Ortopedic Plus and One

Kit Box double Moving disponibles para somieres: Ortopedic Plus and One

Double Moving Coffre, disponible pour somier Ortopedic Plus et One

For technical data sheet and and surcharges, see page 252 - 264

Para los datos técnicos y los recargos, consultar la página 252 - 264

Pour les fiches techniques et les suppléments, voir p. 252 - 264

+ 290

Custom made - A la medida - Sur mesure

For any changes contact the company

Para cambios contactar la empresa

Pour les modifications, contactez l'entreprise pour vérifier sa faisabilité

twils.it

Twils s.r.l.

Via degli Olmi, 5 - 31040 Cessalto (TV)

Tel. +39 0421 469011 r.a - Fax +39 0421 327916

Tel. +39 0421 469090 uff. comm. - Tel. +39 0421 469050 uff. sped.

commerciale.italia@twils.it - export@twils.it - info@twils.it